

ΠΑΝΕΠΙΣΤΗΜΙΟ ΙΩΑΝΝΙΝΩΝ
ΙΝΣΤΙΤΟΥΤΟ ΜΕΛΕΤΩΝ ΝΕΟΕΛΛΗΝΙΚΗΣ ΦΙΛΟΣΟΦΙΑΣ
ΔΙΕΥΘΥΝΤΗΣ: ΕΠ. ΚΑΘΗΓΗΤΗΣ ΚΩΝΣΤΑΝΤΙΝΟΣ Θ. ΠΕΤΣΙΟΣ

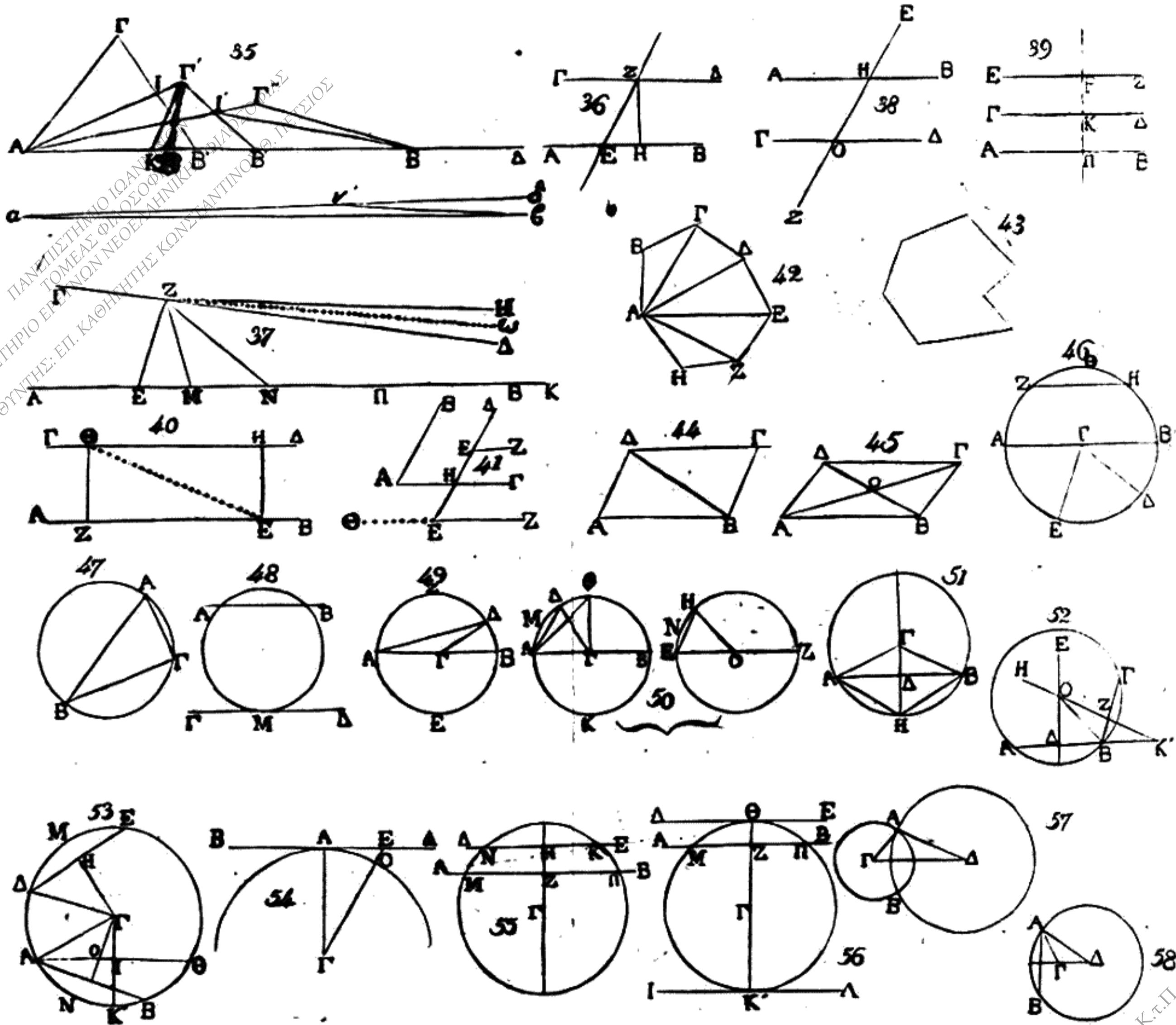

ΠΑΝΕΠΙΣΤΗΜΙΟ ΙΩΑΝΝΙΝΩΝ
ΤΟΜΕΑΣ ΦΙΛΟΣΟΦΙΑΣ
ΔΕΥΤΕΡΗΣ ΕΠΙ. ΚΑΘΗΓΗΤΗΣ ΚΩΝΣΤΑΝΤΙΝΟΣ Π. ΠΕΤΣΙΟΣ

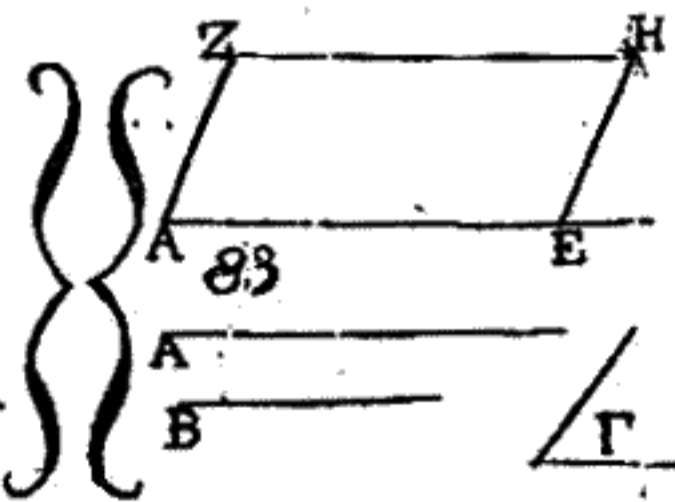

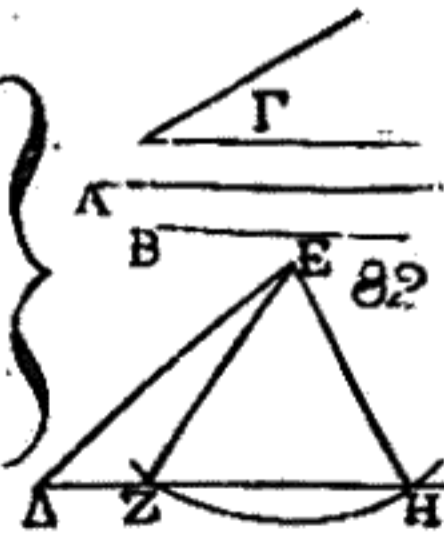
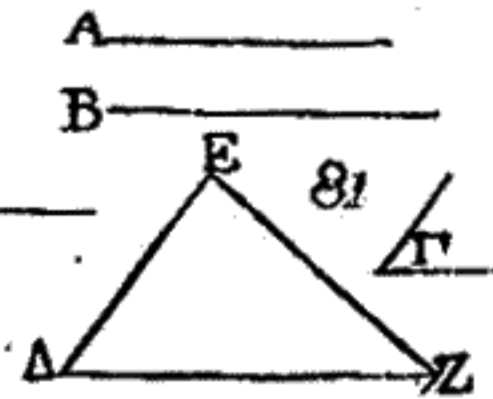
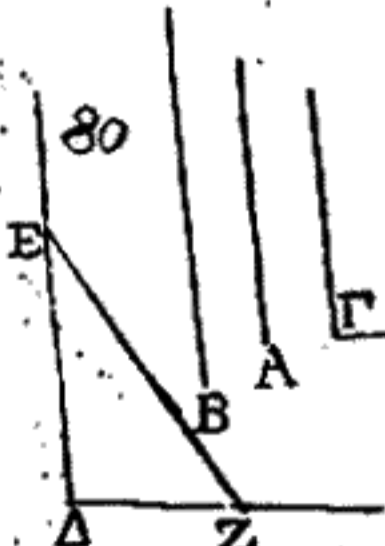
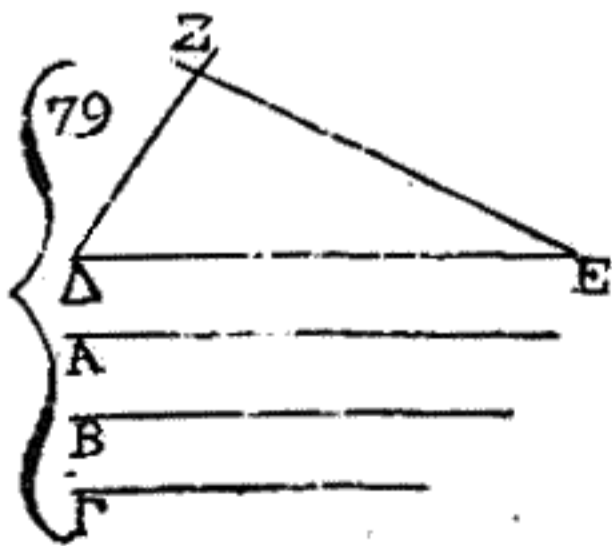
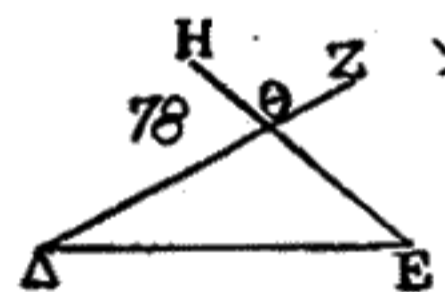
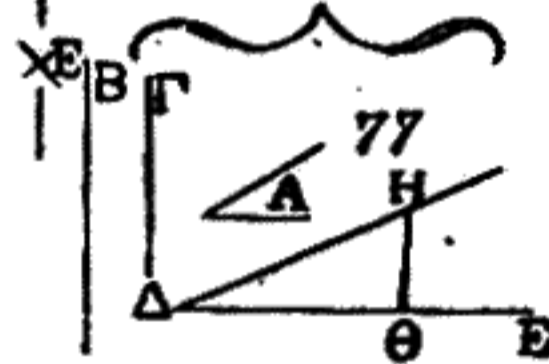
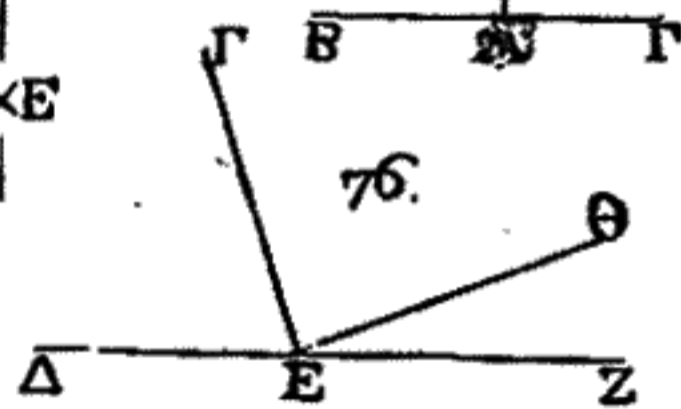
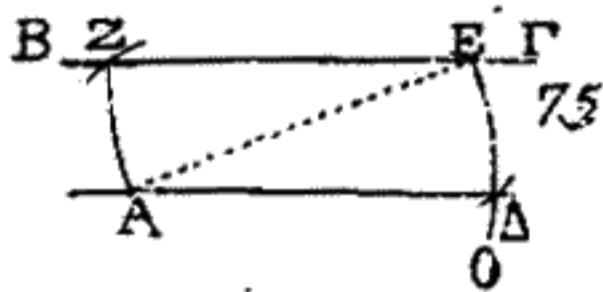
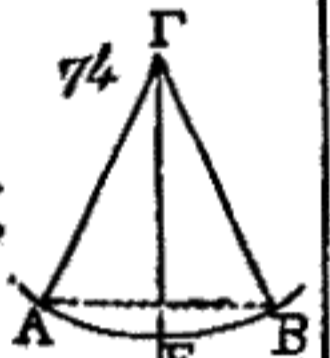
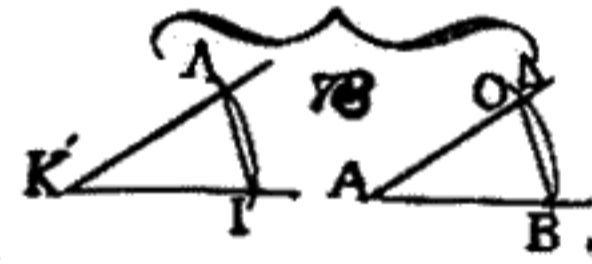
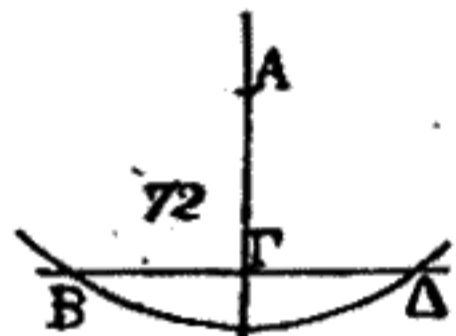
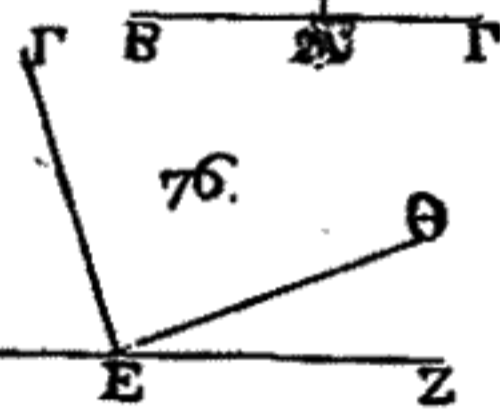
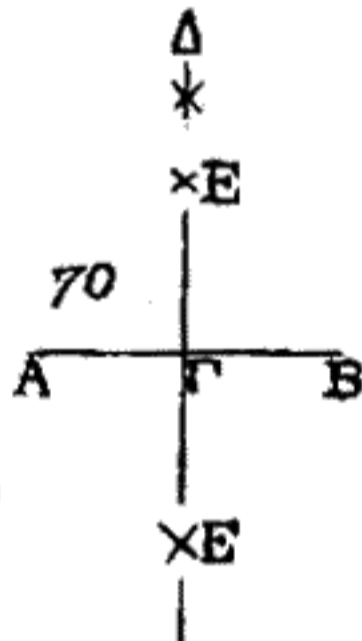
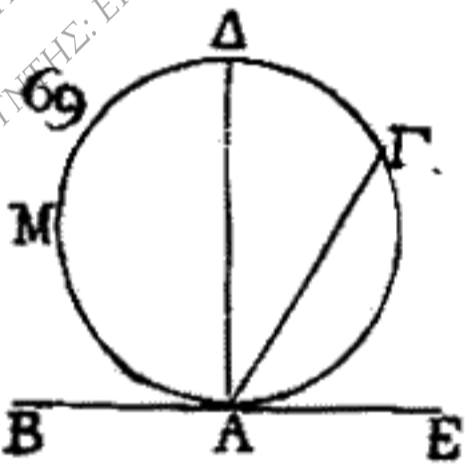
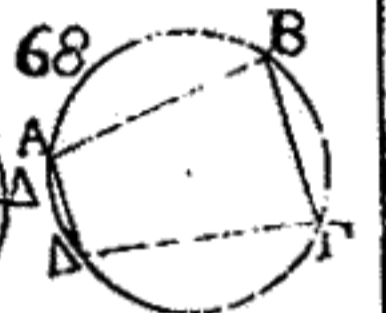
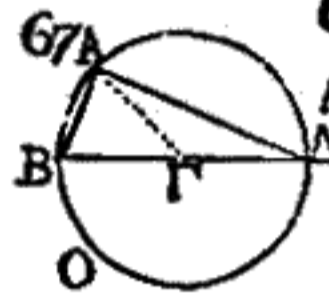
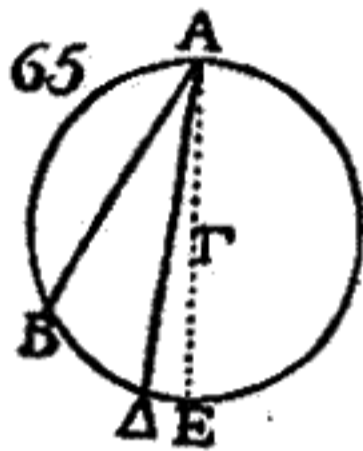
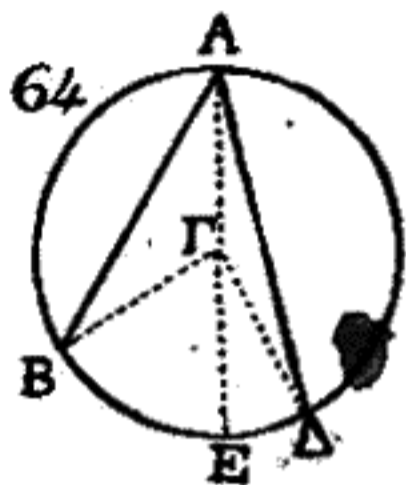
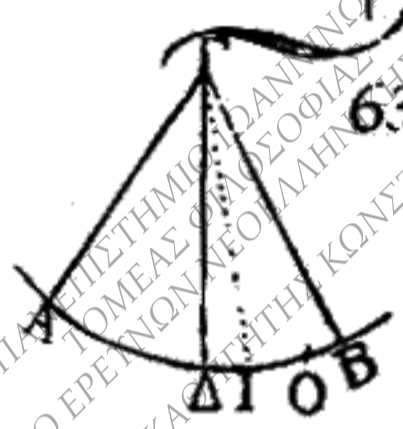
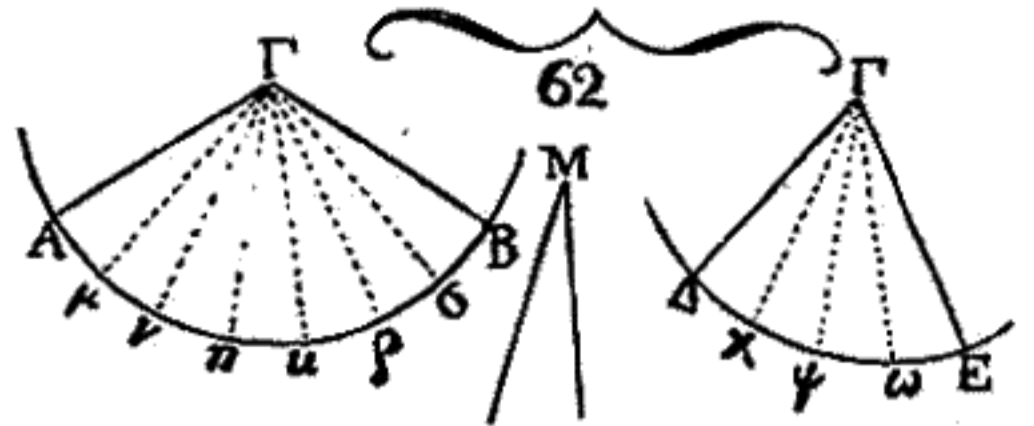
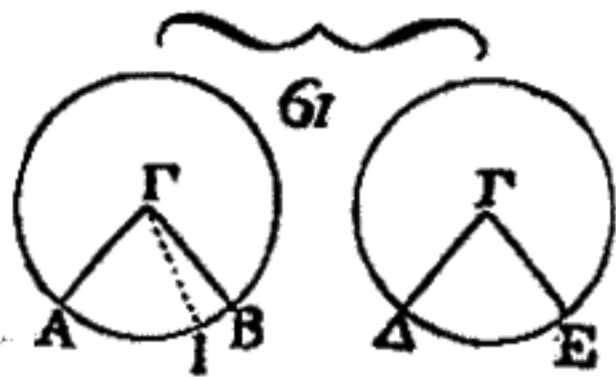
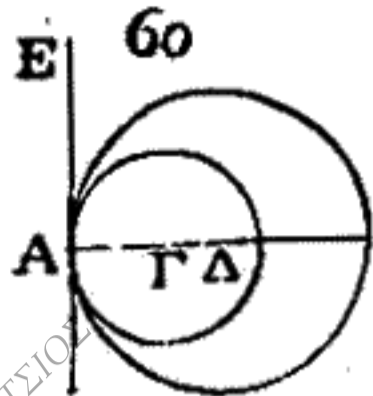
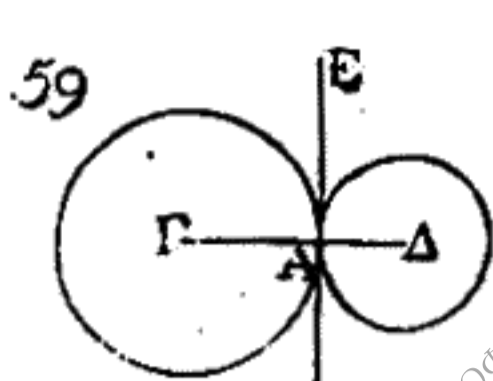
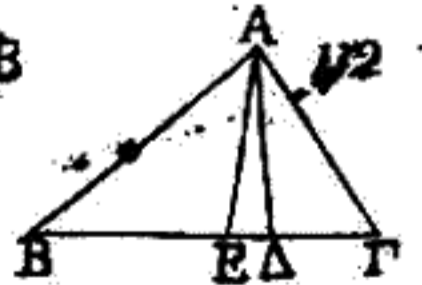
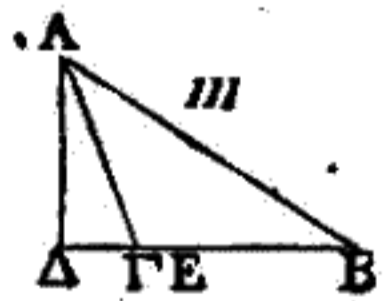
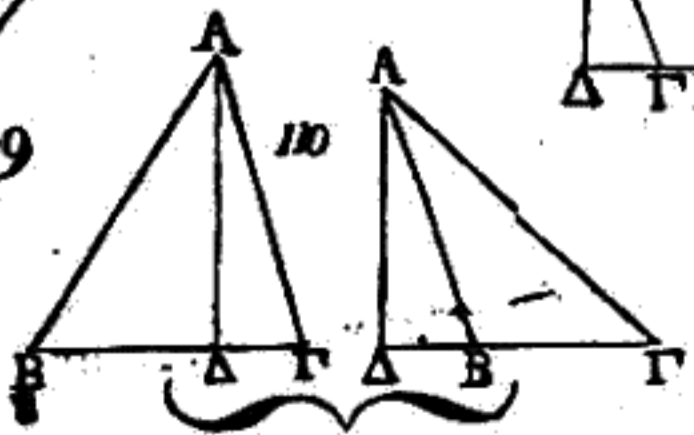
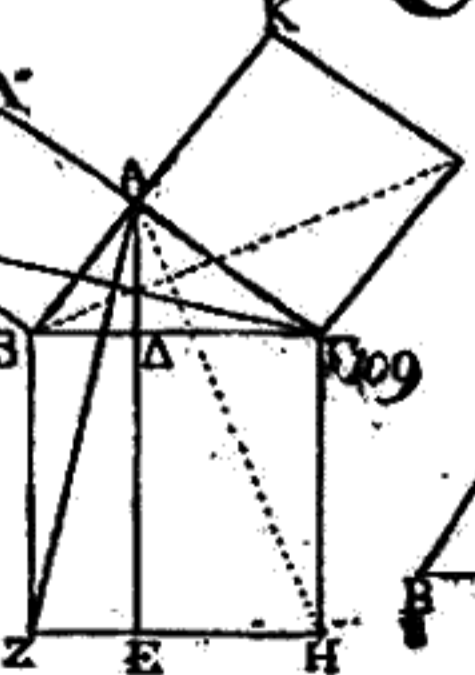
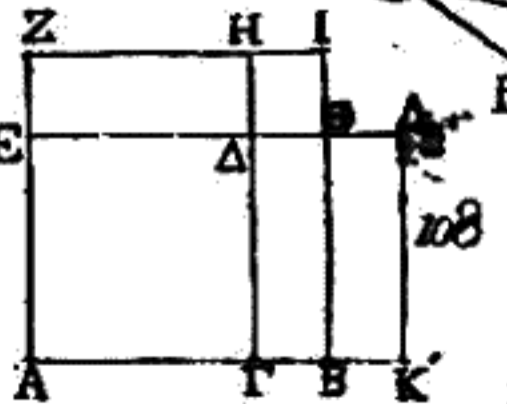
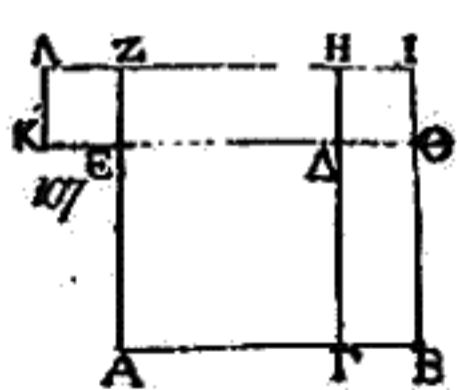
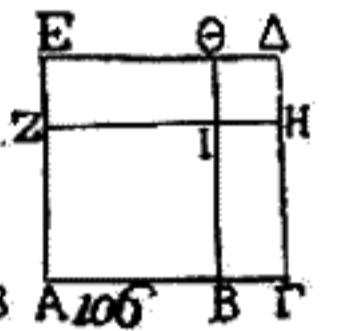
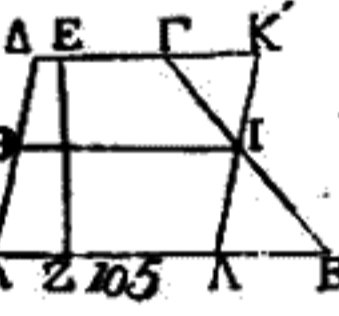
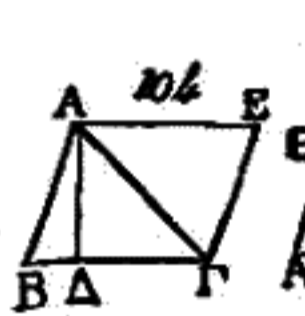
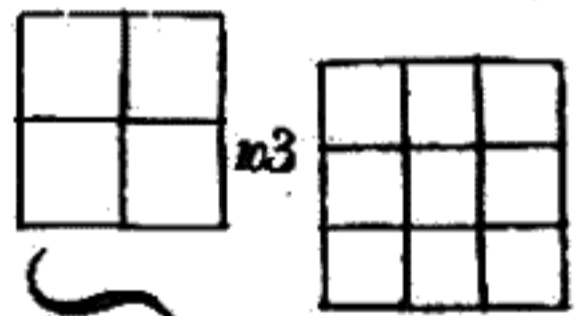
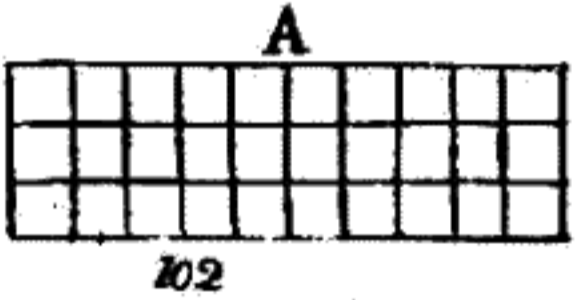
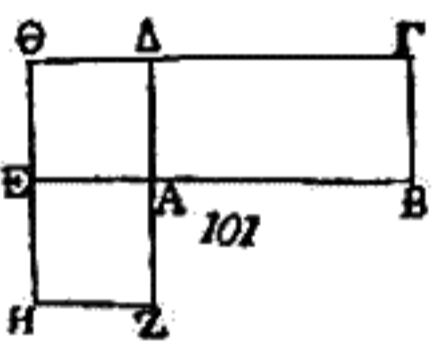
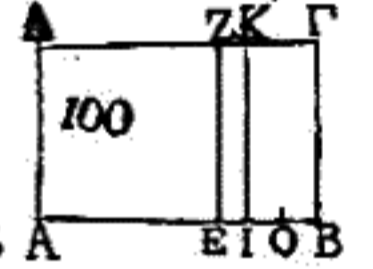
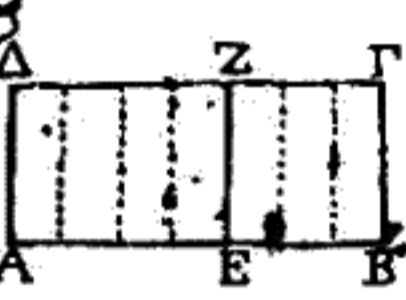
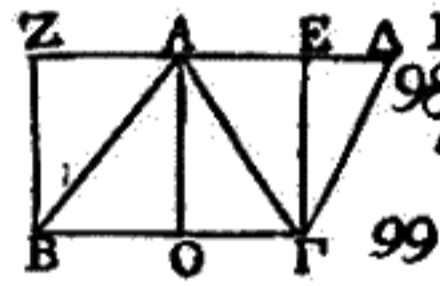
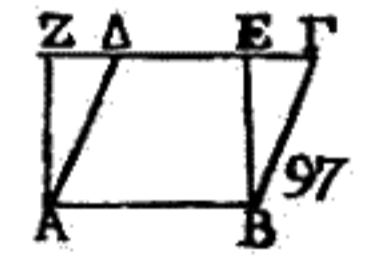
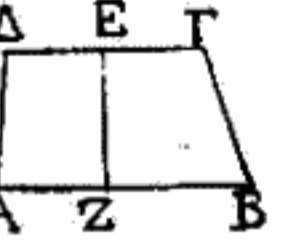
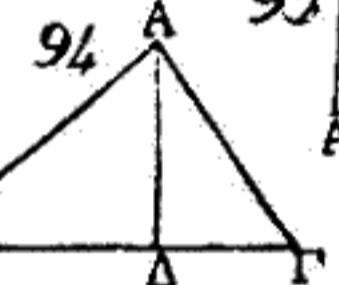
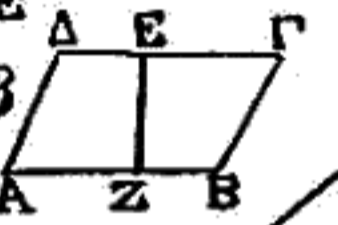
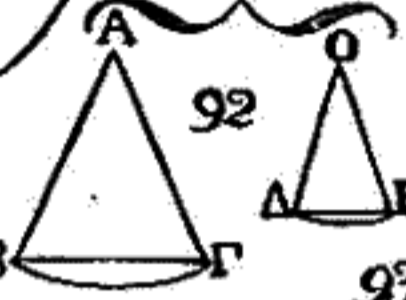
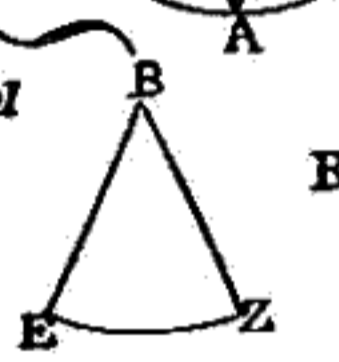
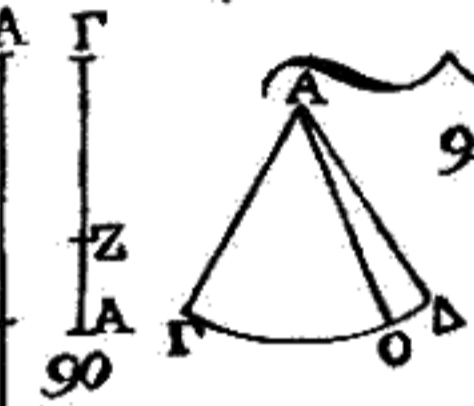
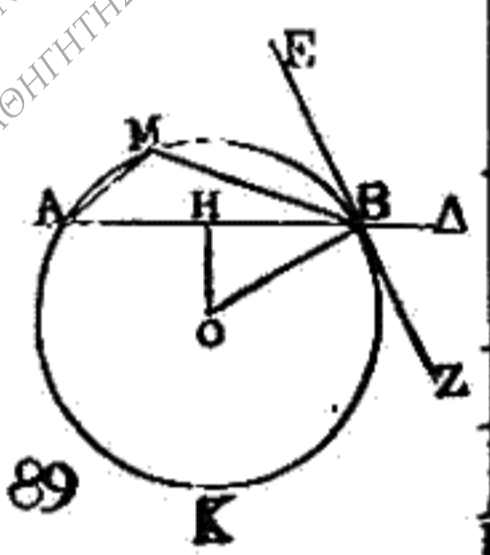
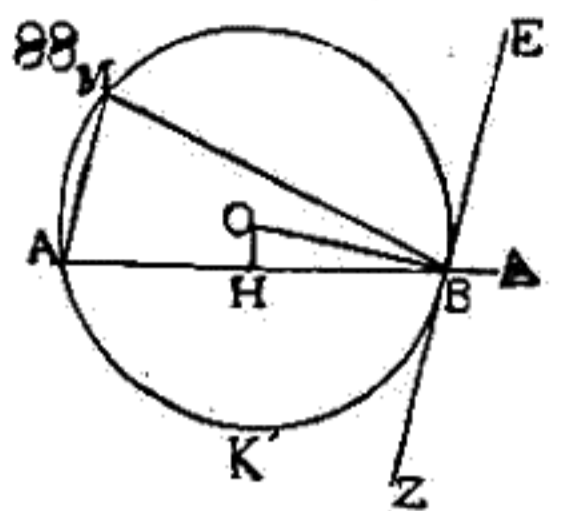
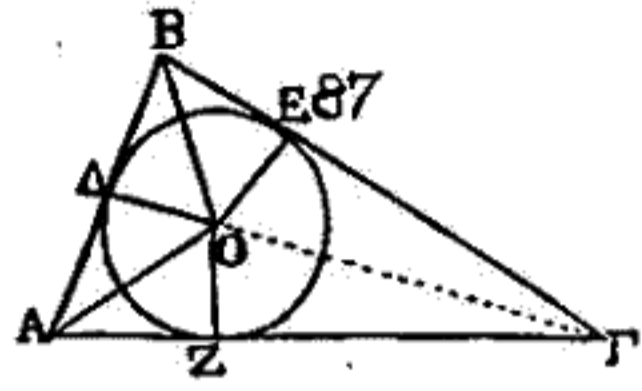
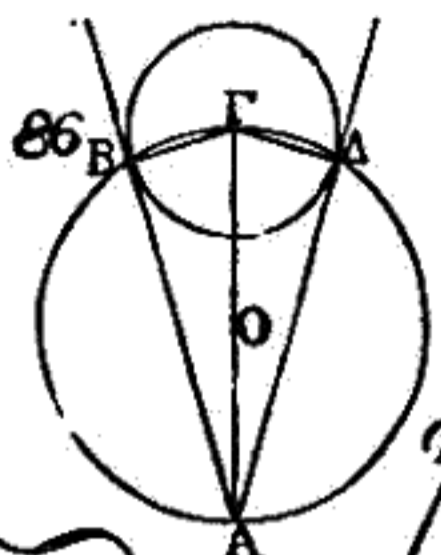
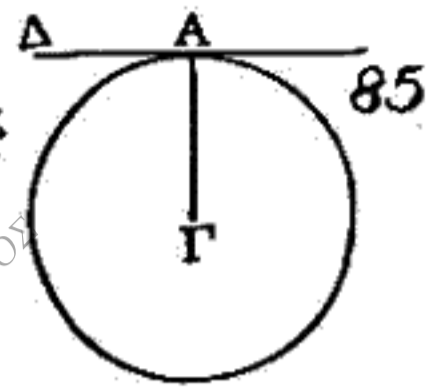
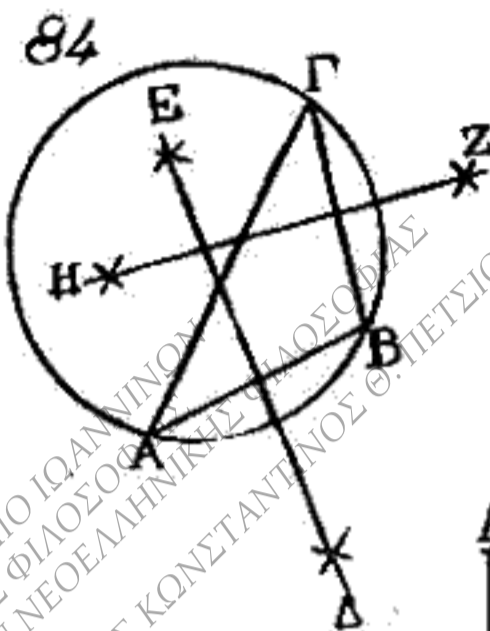

ΠΑΝΕΠΙΣΤΗΜΙΟ ΙΩΑΝΝΙΝΩΝ
 ΤΟΜΕΑΣ ΦΙΛΟΣΟΦΙΑΣ
 ΔΙΕΥΘΥΝΤΗΣ: ΕΠ. ΚΑΘΗΓΗΤΗΣ ΚΩΝΣΤΑΝΤΙΝΟΣ Θ. ΠΙΕΤΣΙΟΣ

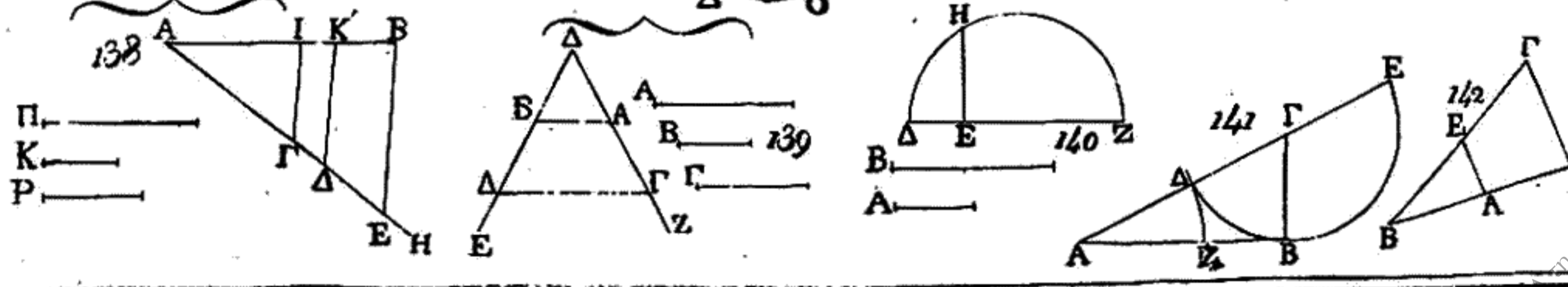
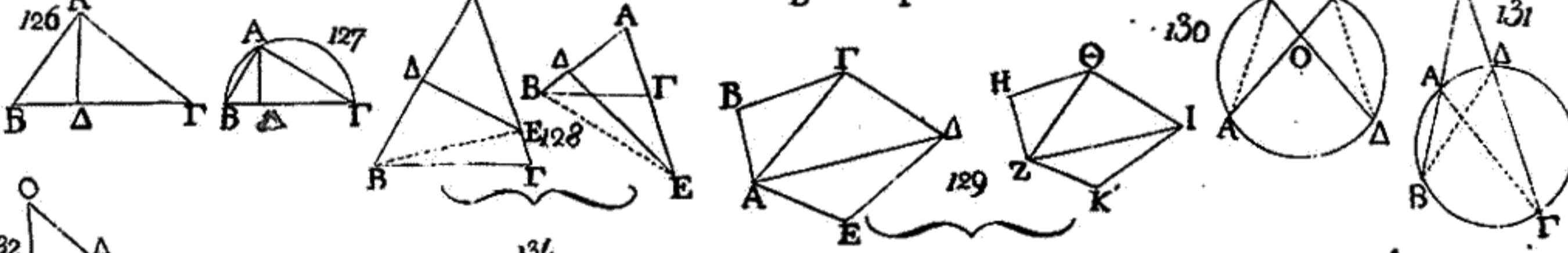
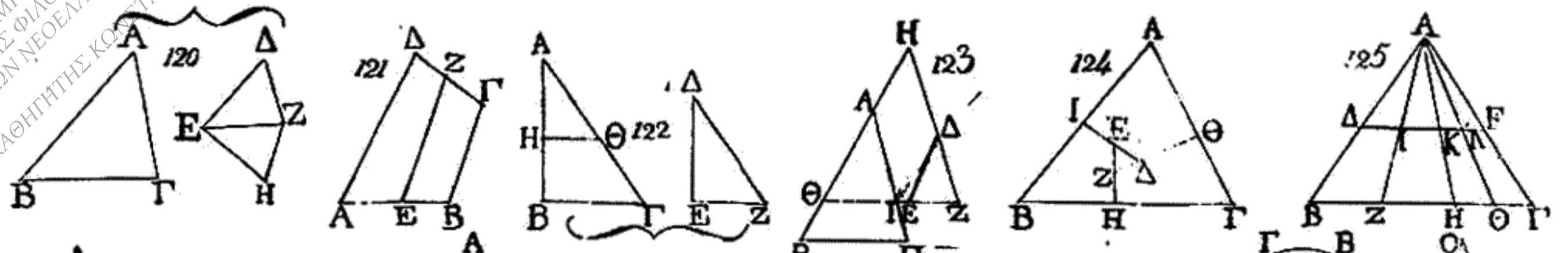
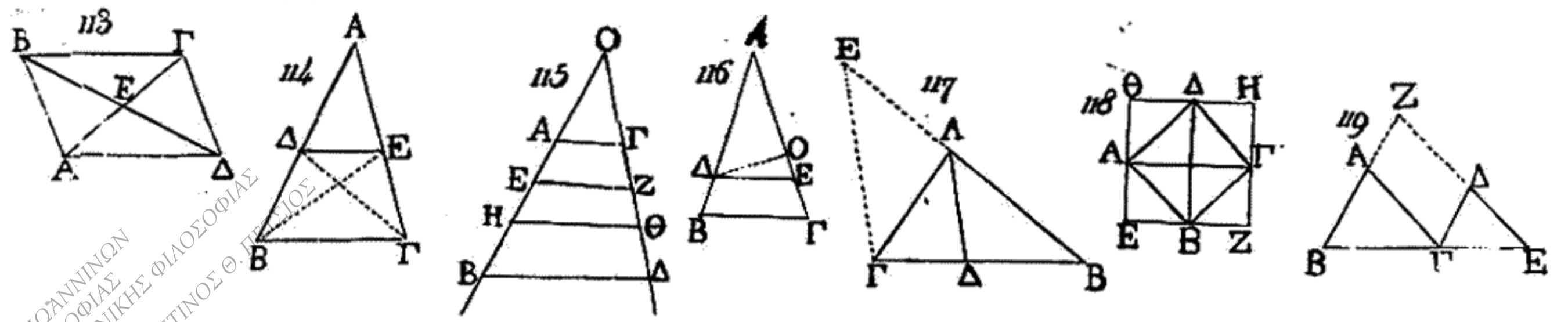

ΠΑΝΕΠΙΣΤΗΜΙΟ ΙΩΑΝΝΙΝΩΝ
 ΕΡΓΑΣΤΗΡΙΟ ΕΠΙΣΤΗΜΗΣ ΦΙΛΟΣΟΦΙΑΣ
 ΔΙΕΥΘΥΝΤΗΣ ΕΠ. ΚΑΘΗΓΗΤΗΣ ΚΩΝΣΤΑΝΤΙΝΟΣ Θ. ΓΡΥΛΙΟΣ

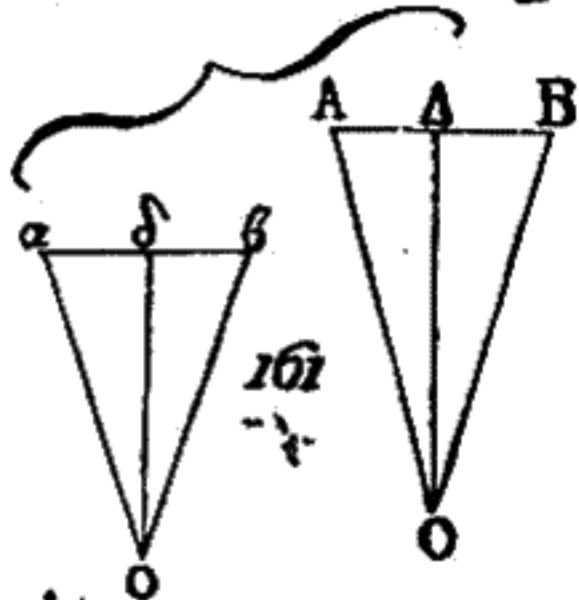
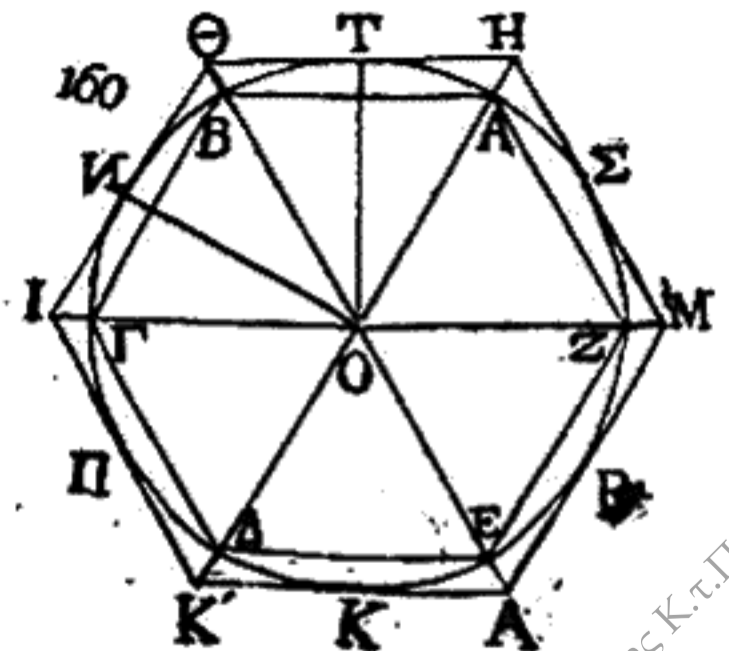
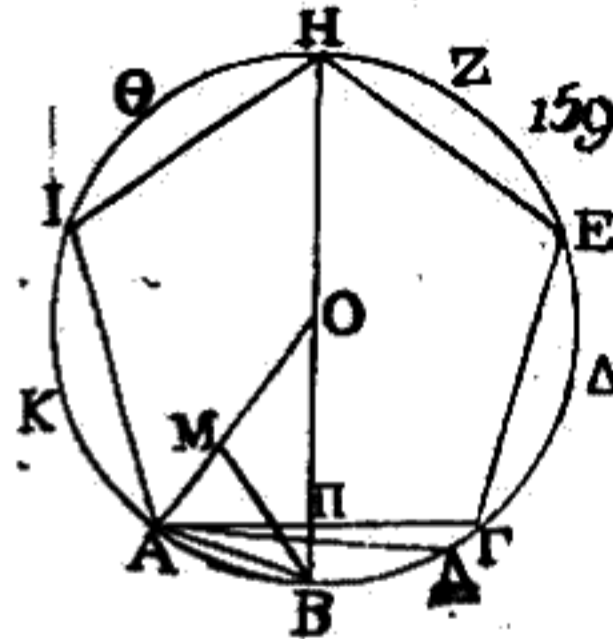
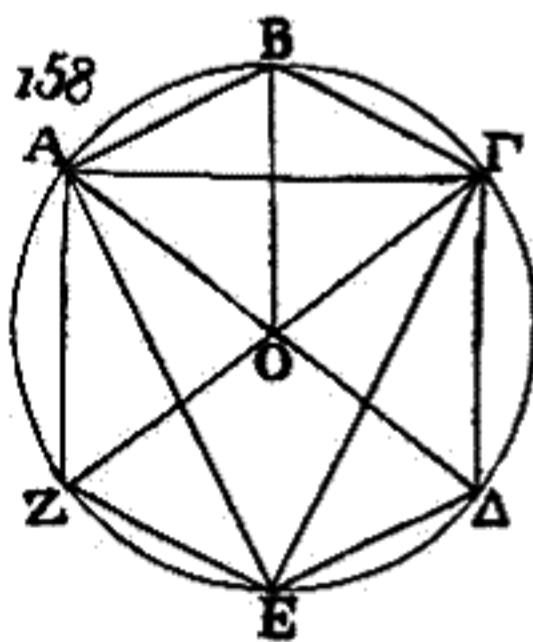
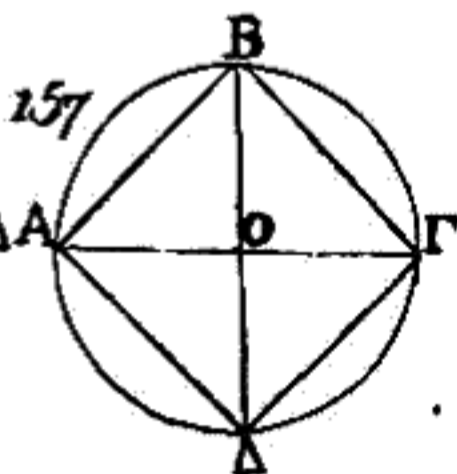
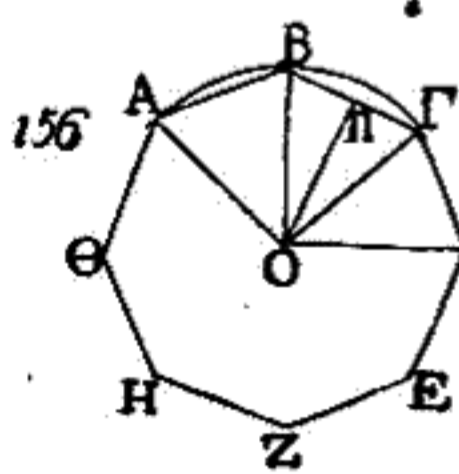
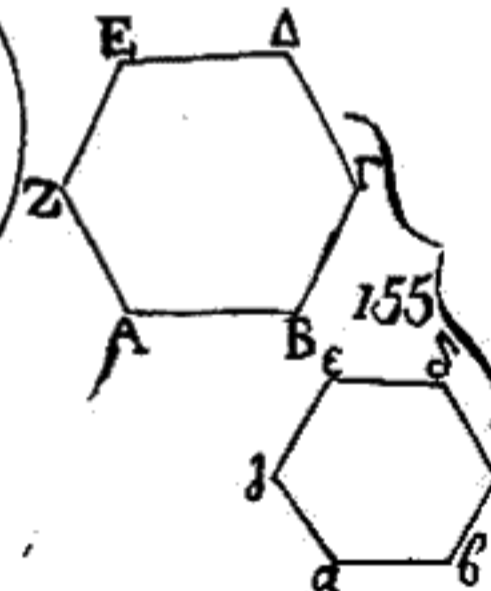
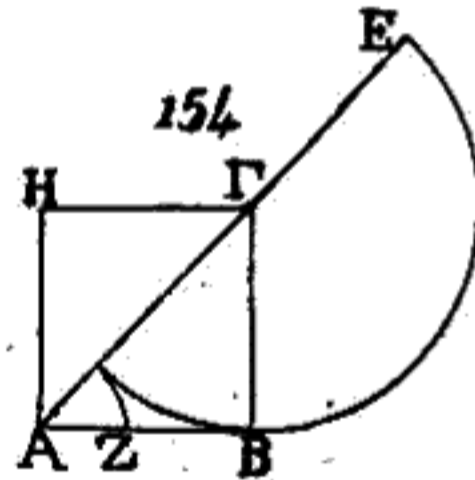
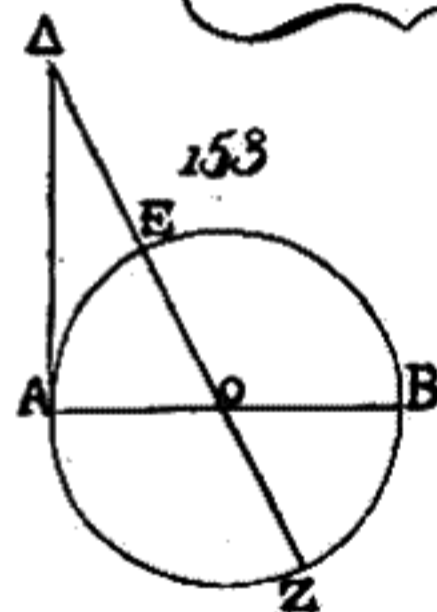
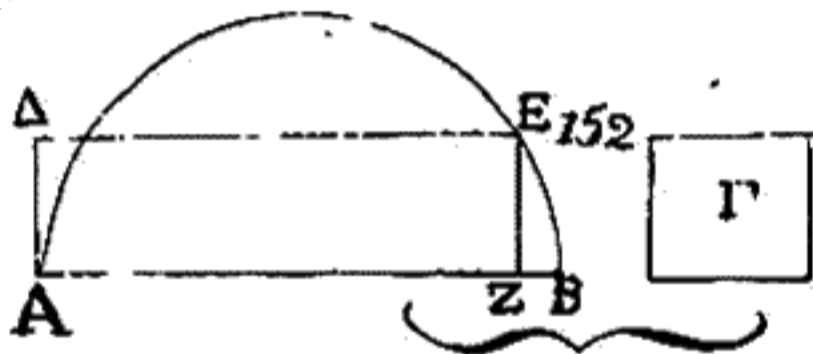
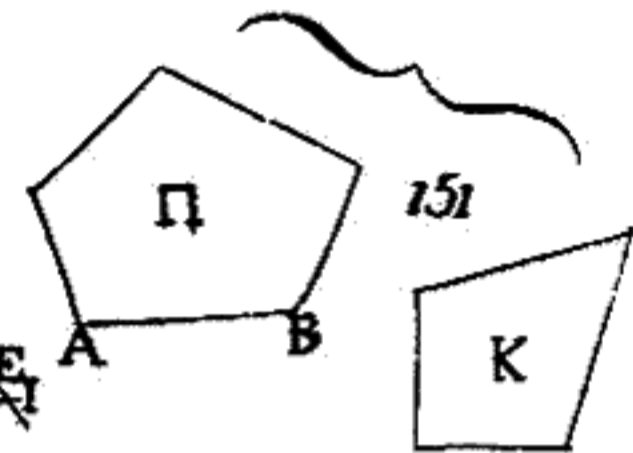
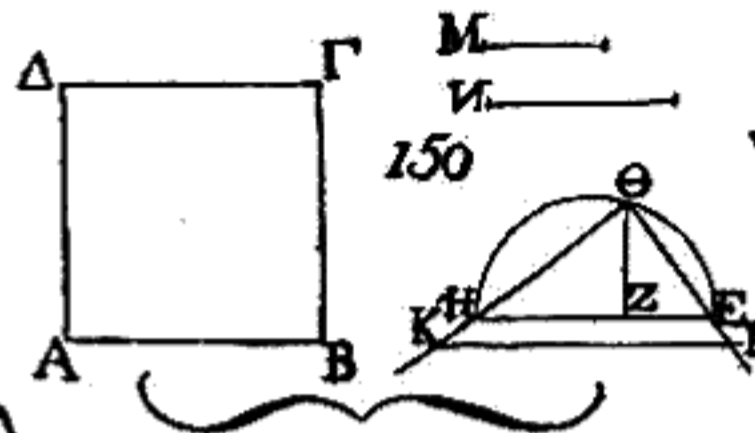
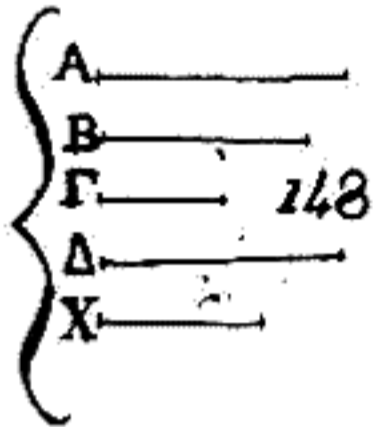
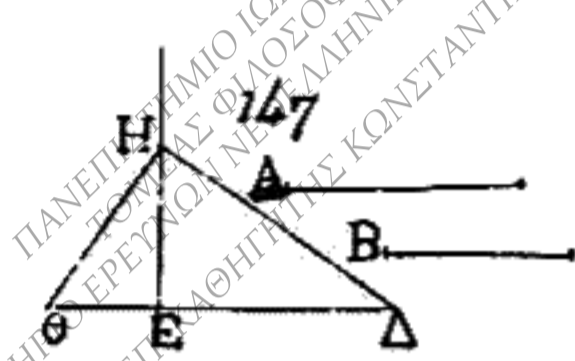
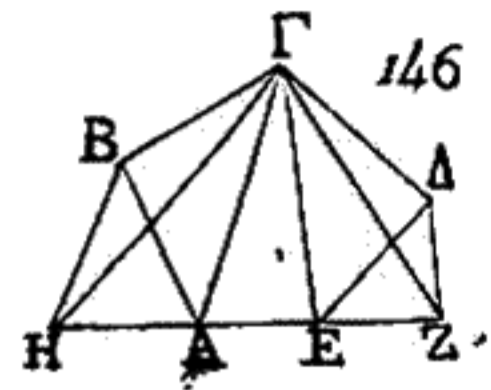
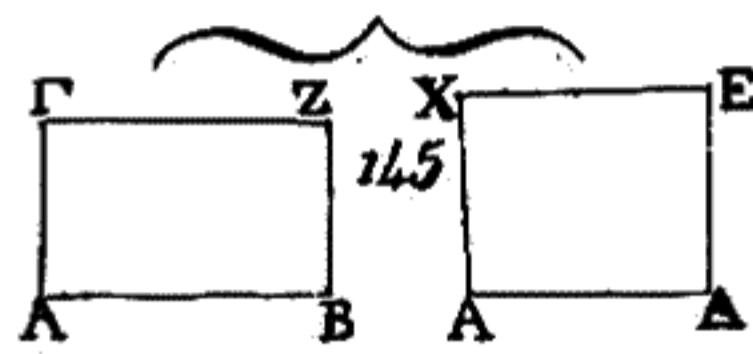
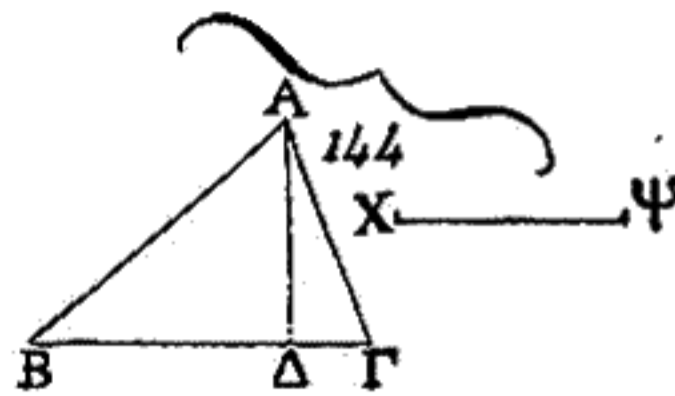
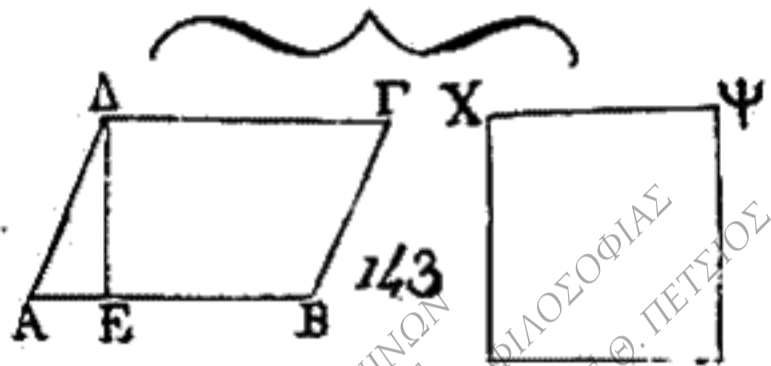

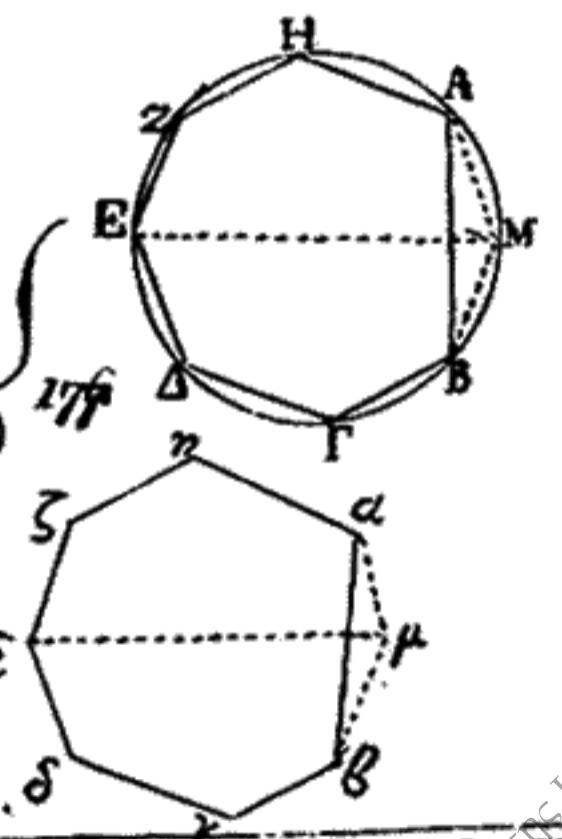
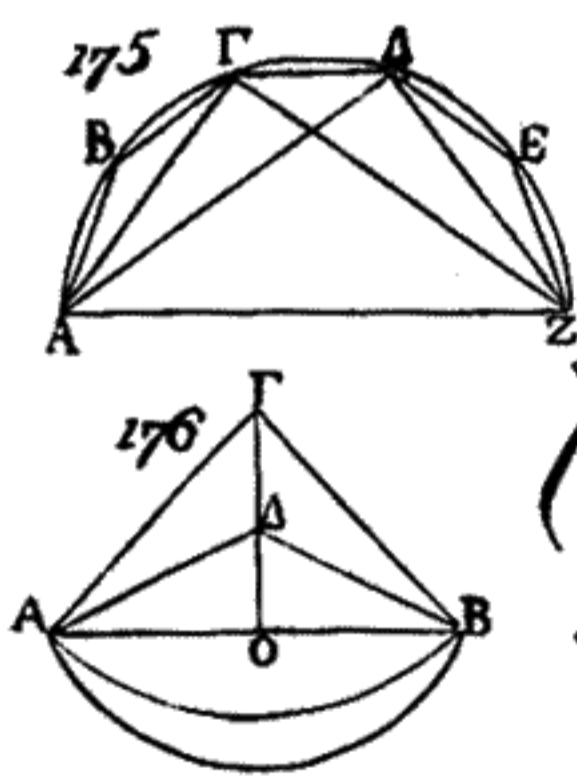
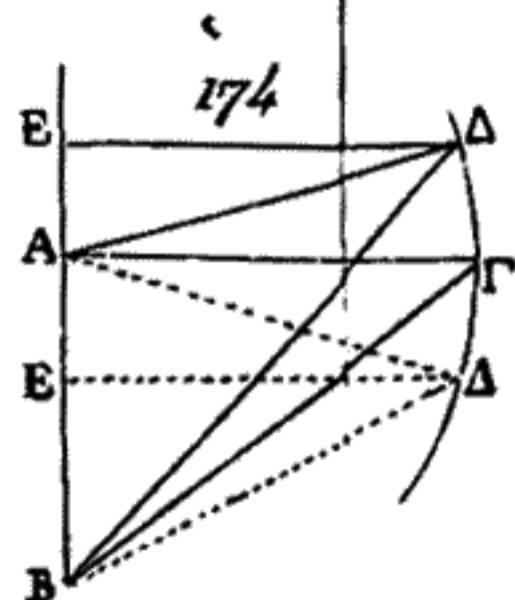
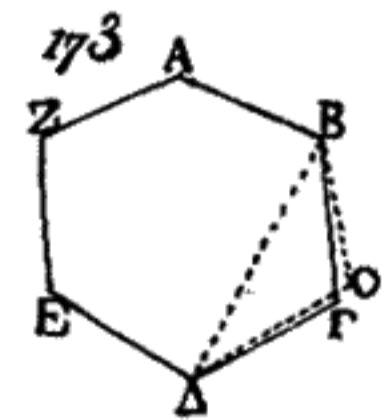
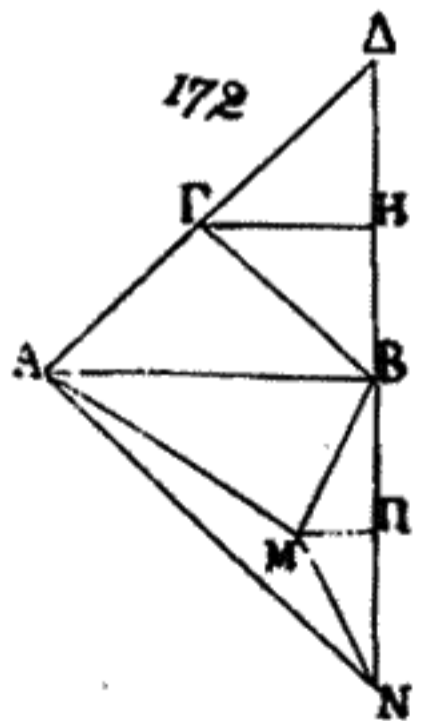
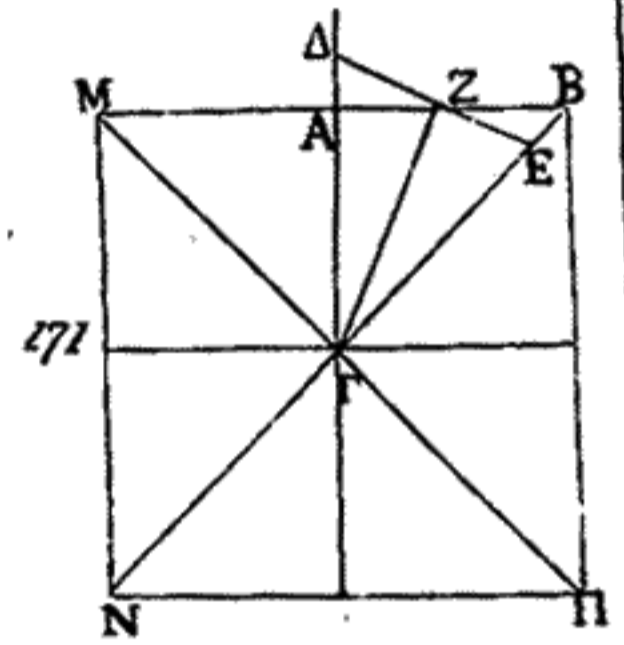
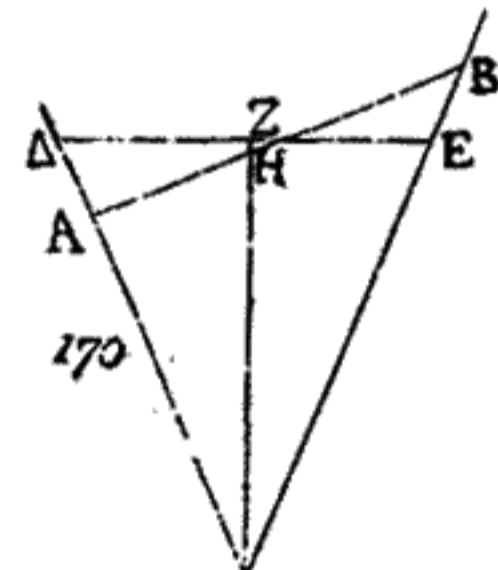
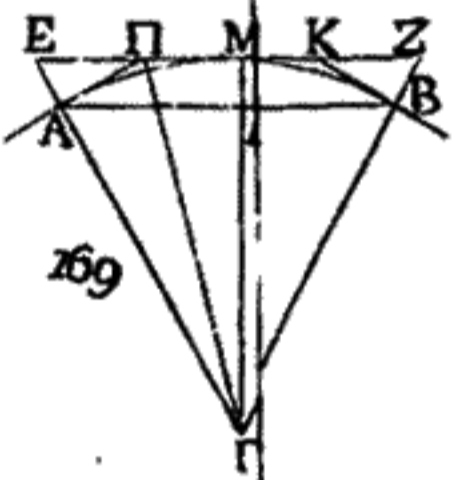
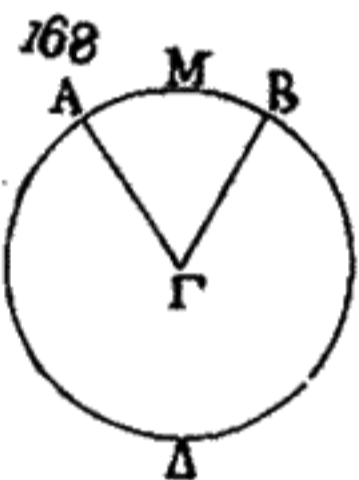
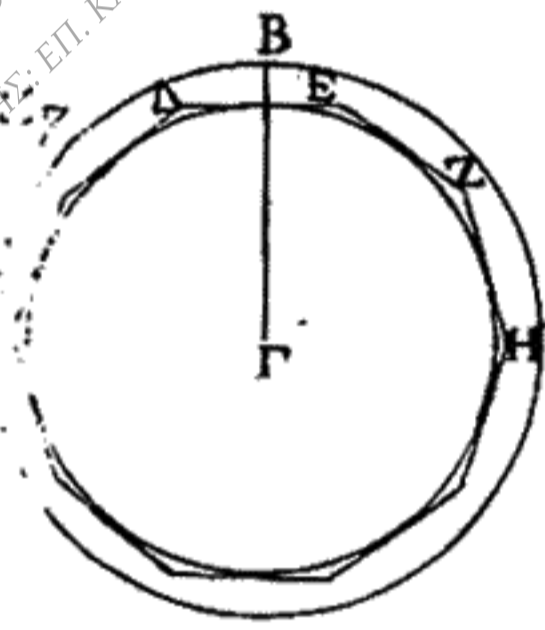
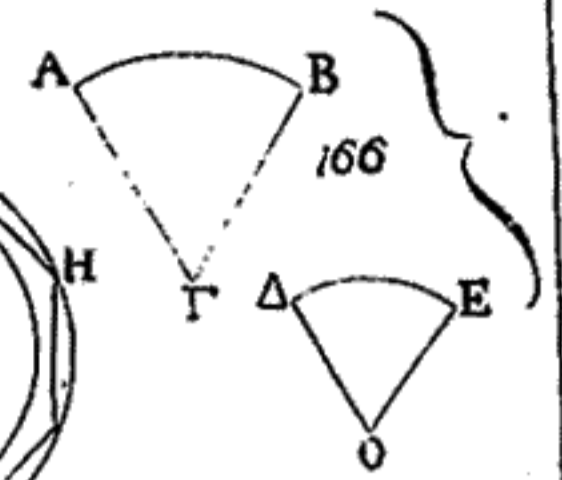
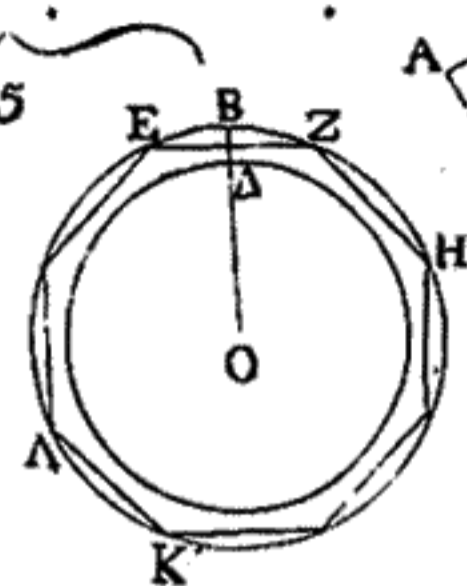
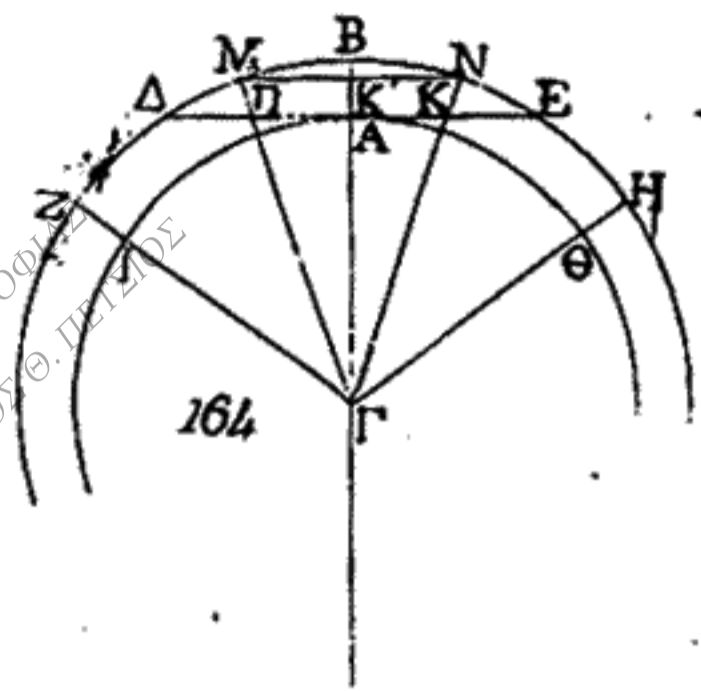
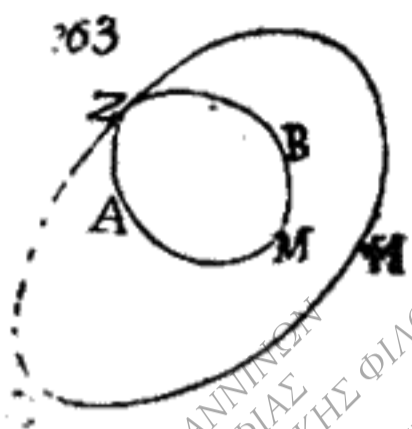

ΕΡΓΑΣΤΗΡΙΟ ΕΡΕΥΝΩΝ ΝΕΟΕΛΛΗΝΙΚΗΣ ΦΙΛΟΣΟΦΙΑΣ
 ΔΙΕΥΘΥΝΤΗΣ: ΕΠ. ΚΑΘΗΓΗΤΗΣ ΚΩΝΣΤΑΝΤΙΝΟΣ Θ. ΠΕΤΡΟΥΣ
 ΠΑΝΕΠΙΣΤΗΜΙΟ ΙΩΑΝΝΙΝΩΝ
 ΤΟΜΕΑΣ ΦΙΛΟΣΟΦΙΑΣ

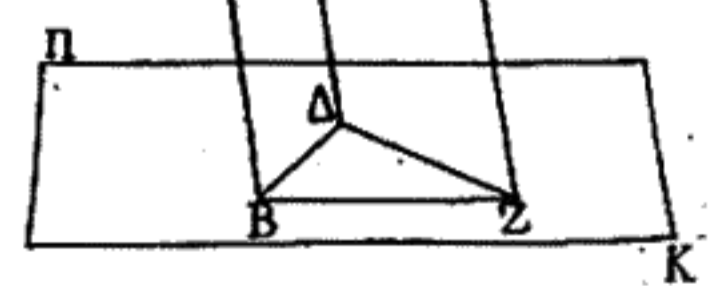
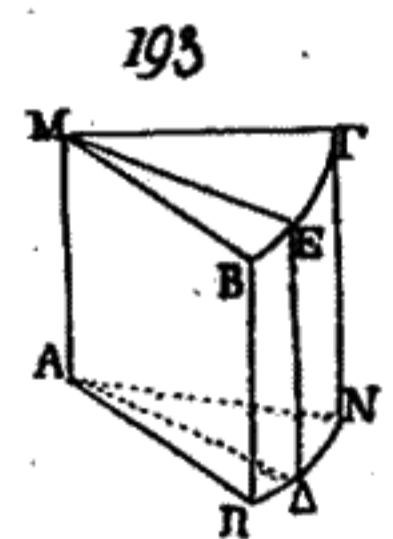
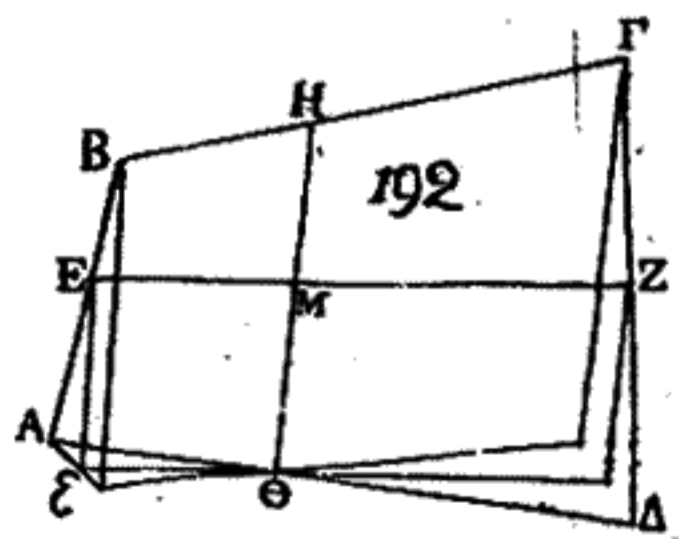
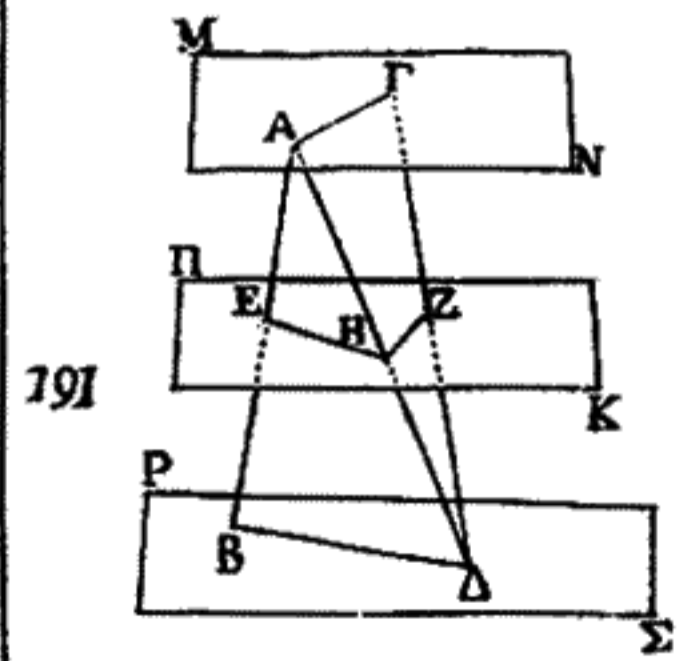
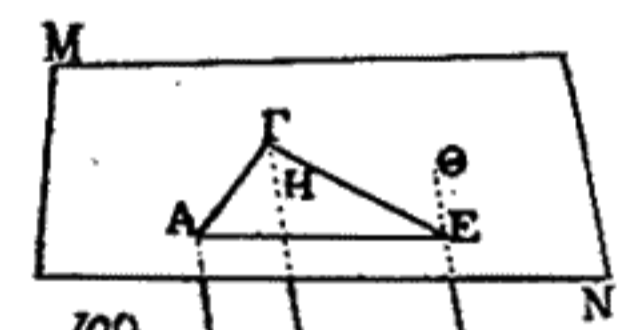
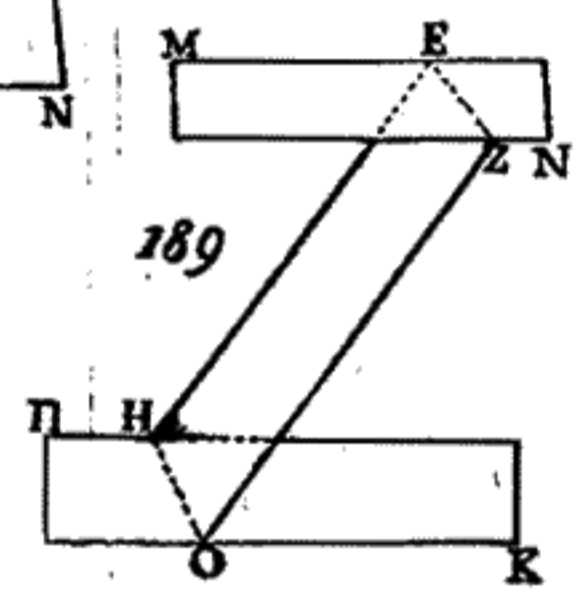
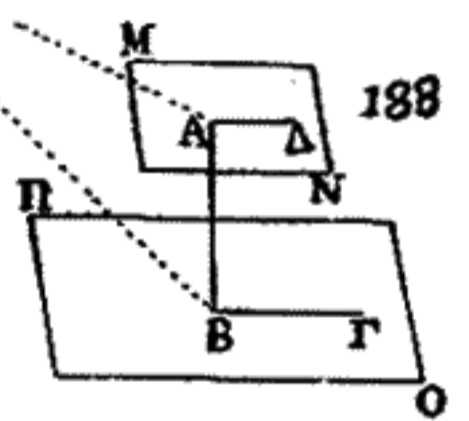
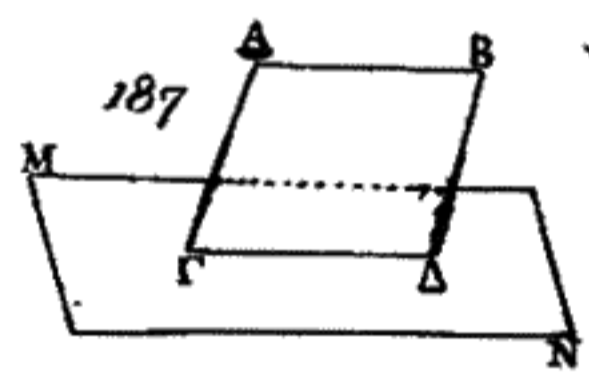
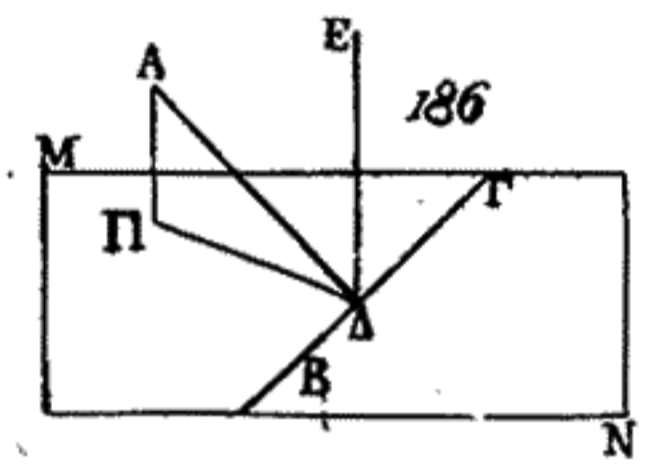
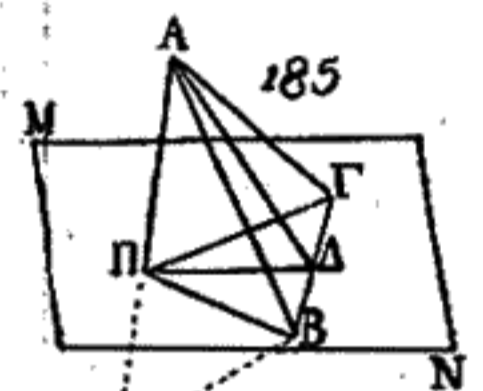
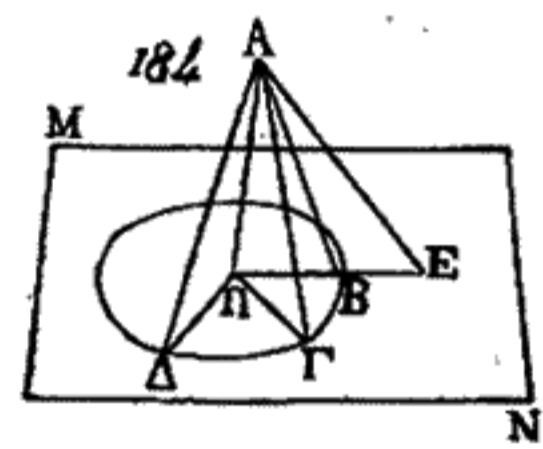
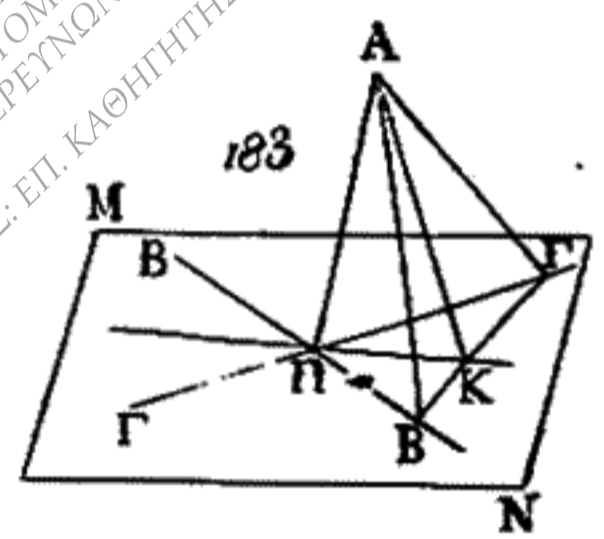
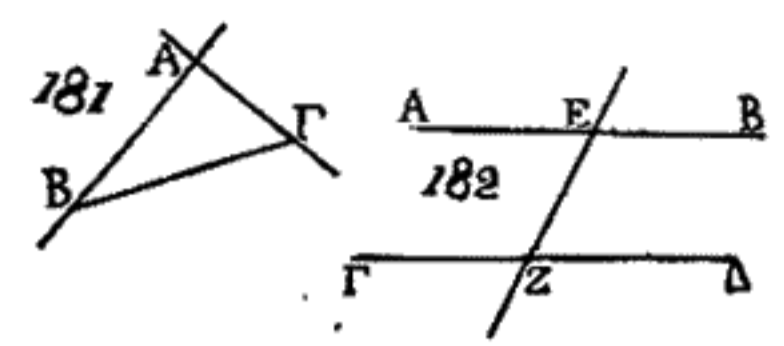
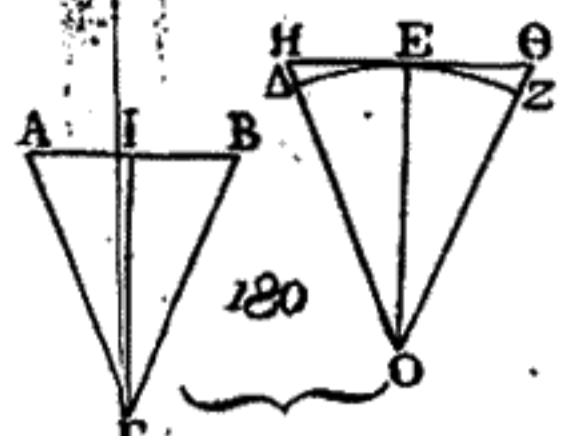
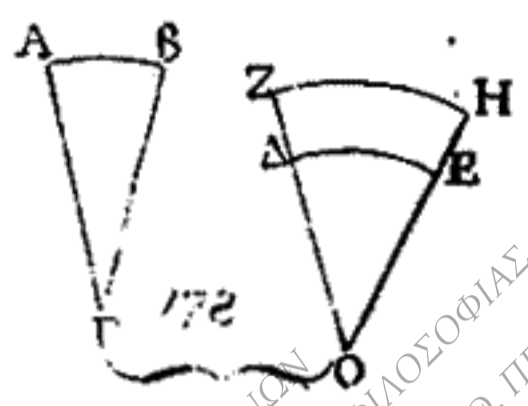

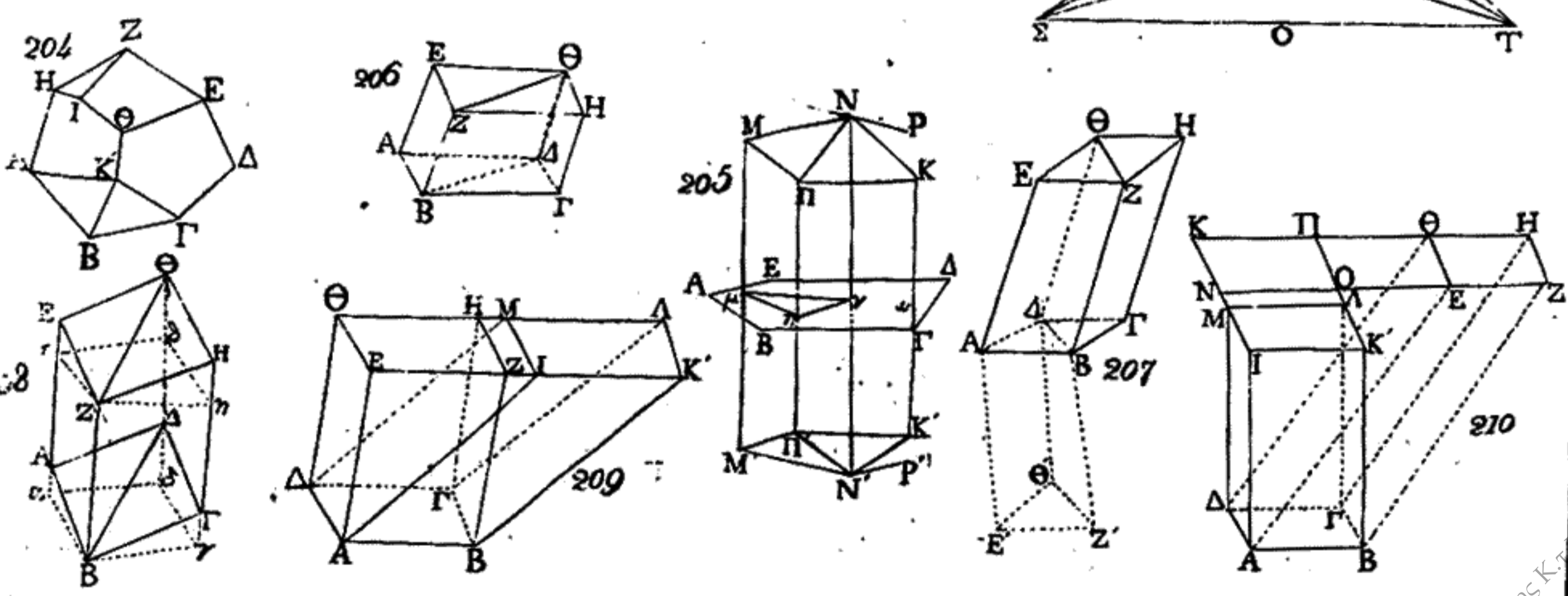
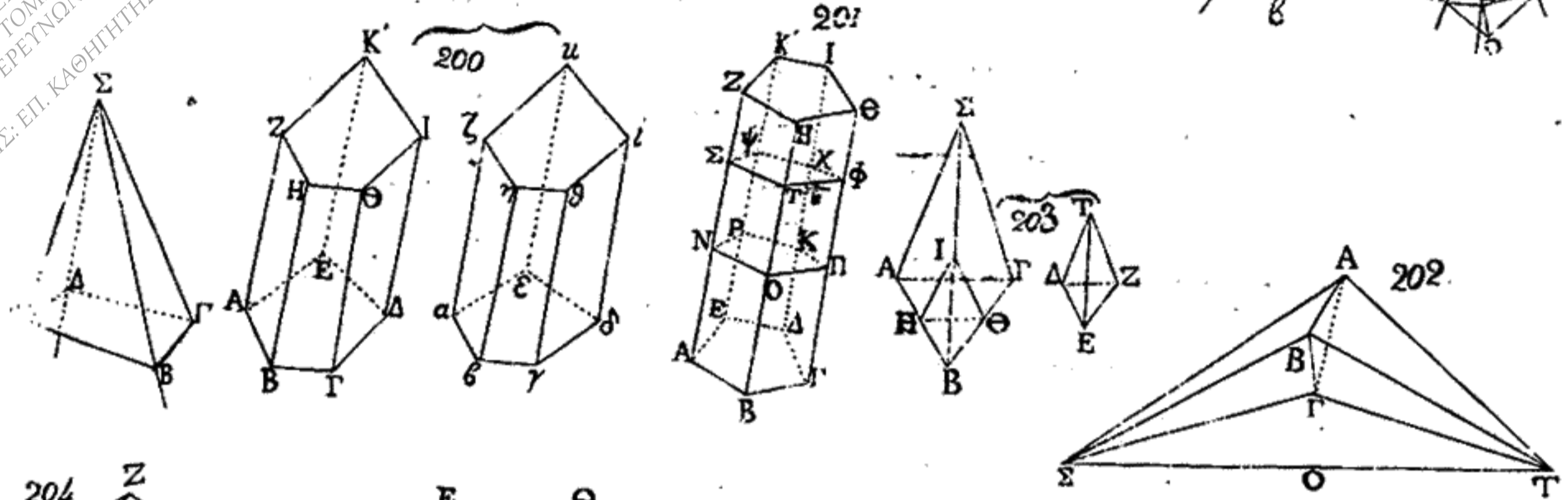
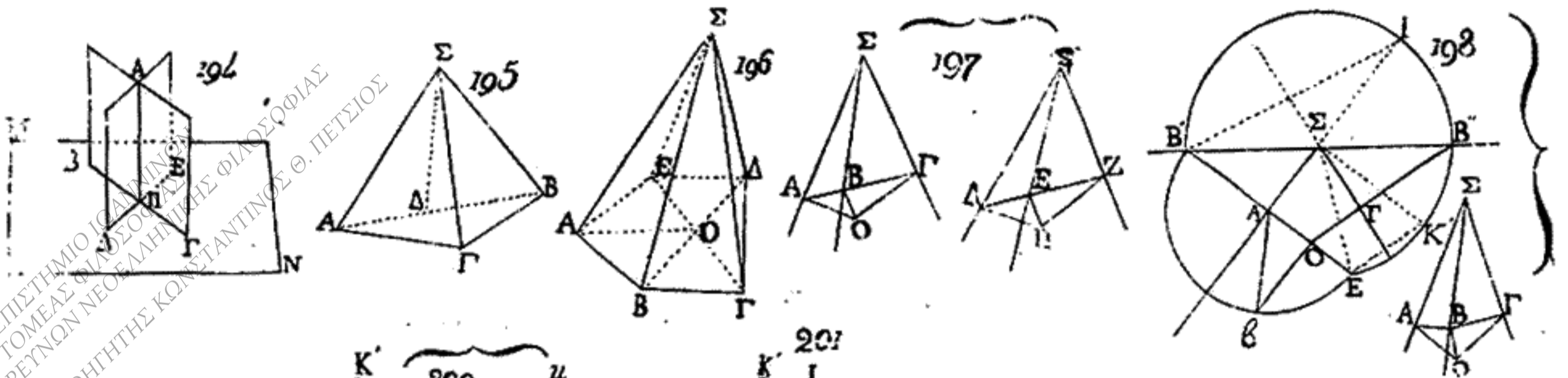

ΠΑΝΕΠΙΣΤΗΜΙΟ ΙΩΑΝΝΙΝΩΝ
 ΤΟΜΕΑΣ ΦΙΛΟΣΟΦΙΑΣ
 ΔΙΕΥΘΥΝΤΗΣ: ΕΠ. ΚΑΘΗΓΗΤΗΣ ΚΩΝΣΤΑΝΤΙΝΟΣ Θ. ΠΕΤΣΙΟΣ

Ε.Σ.Δ της Κ.Ρ.ΔΙ
 ΙΩΑΝΝΙΝΑ 2006

211

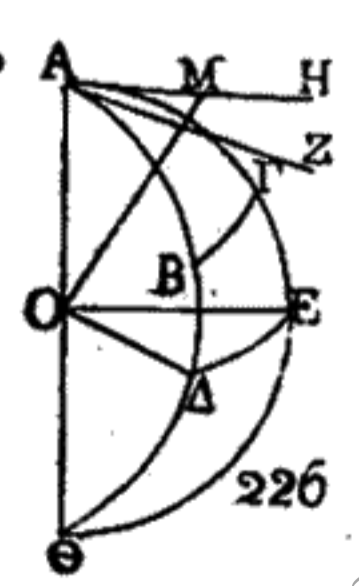
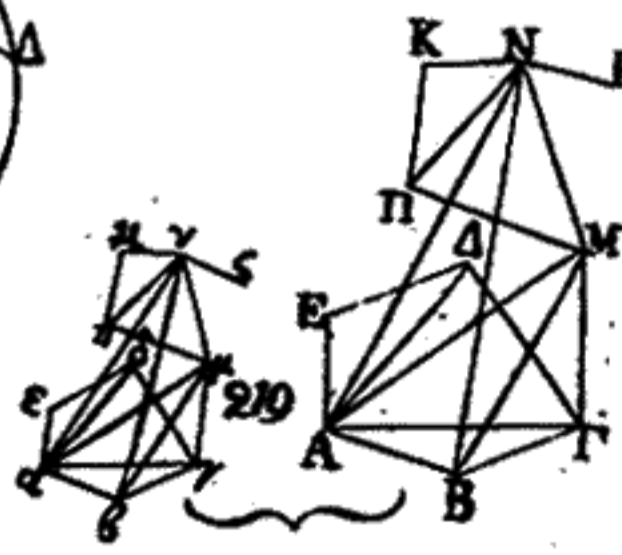
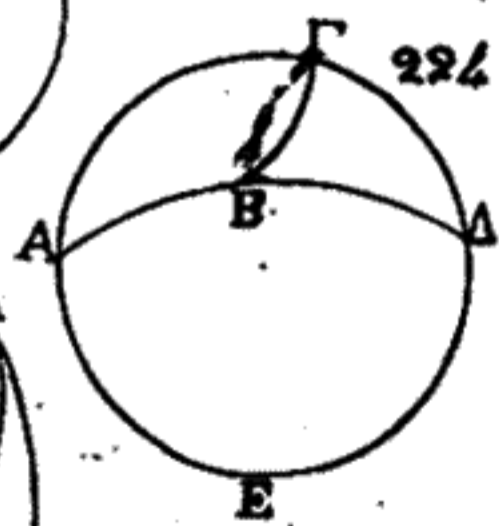
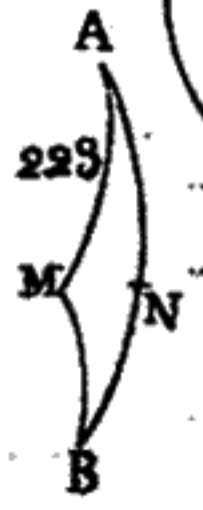
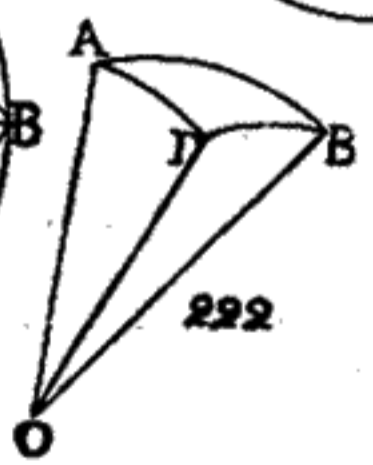
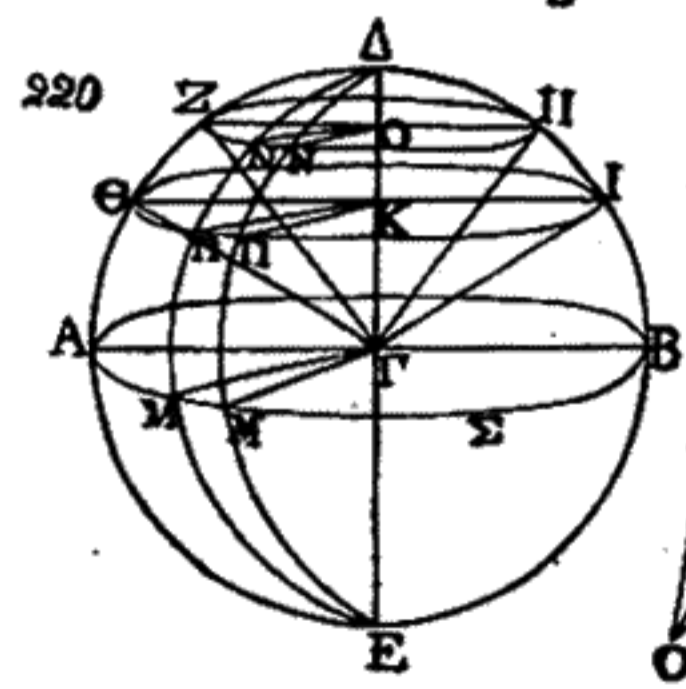
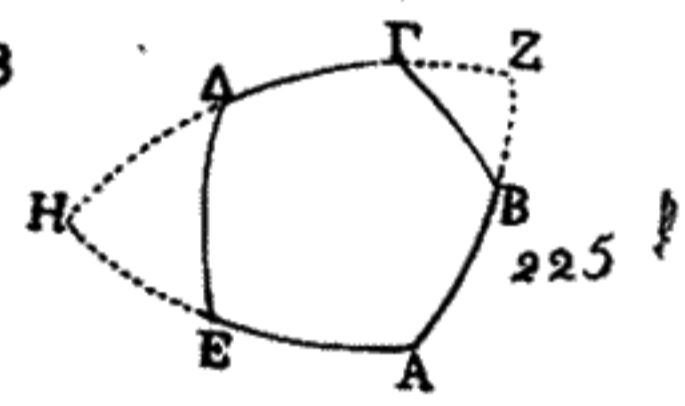
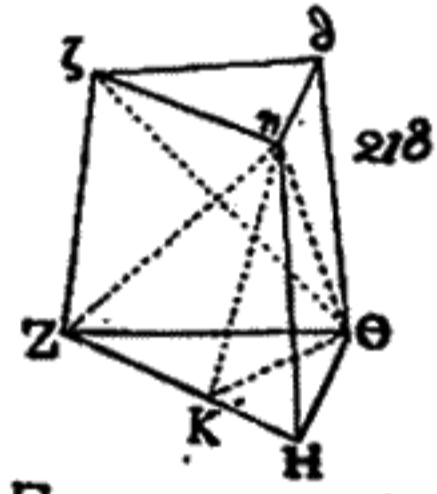
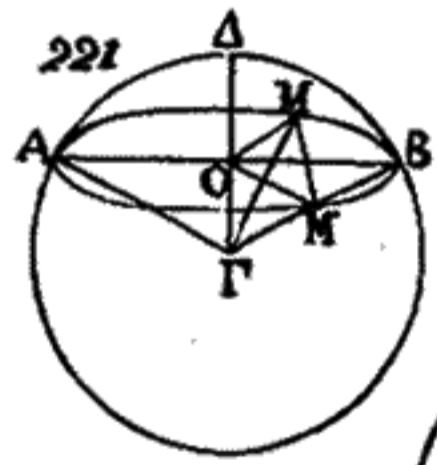
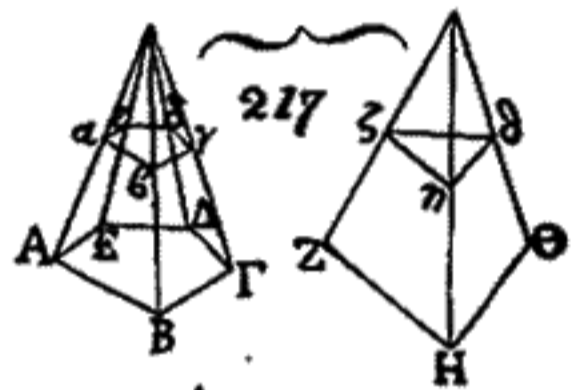
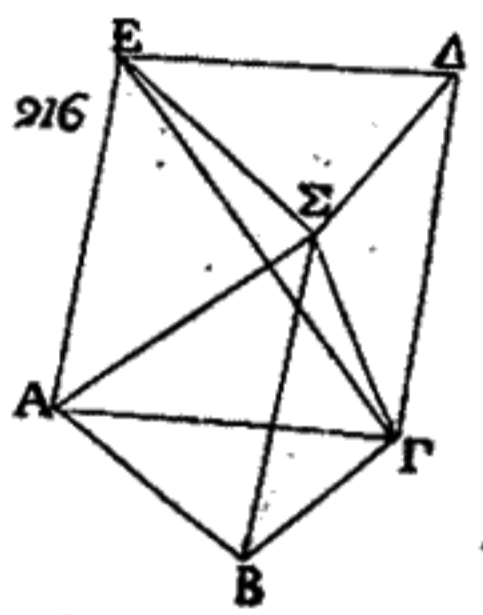
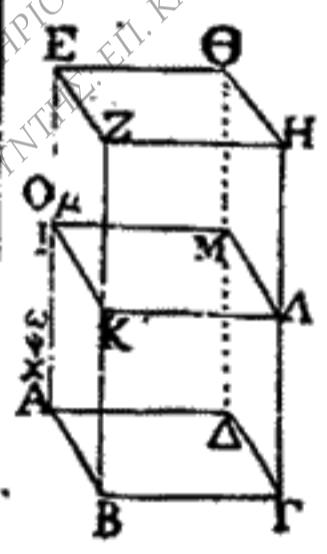
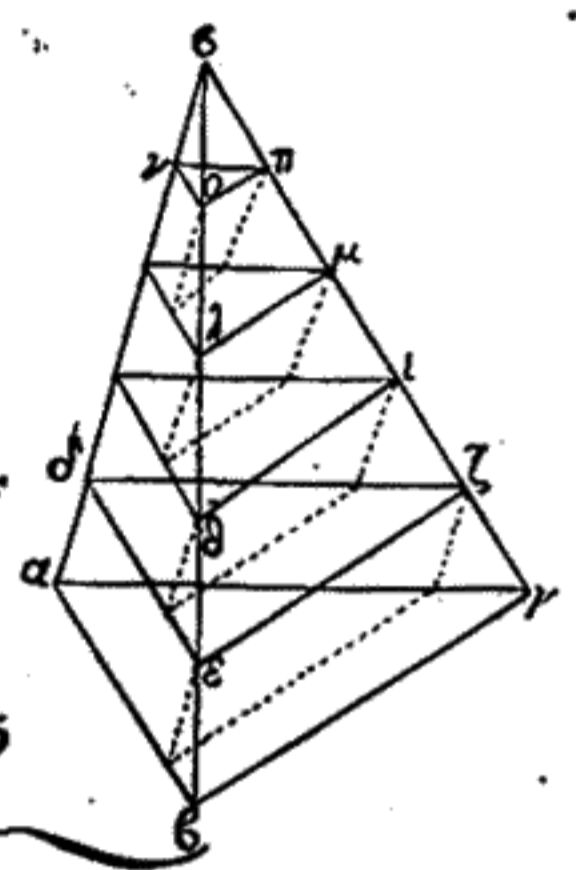
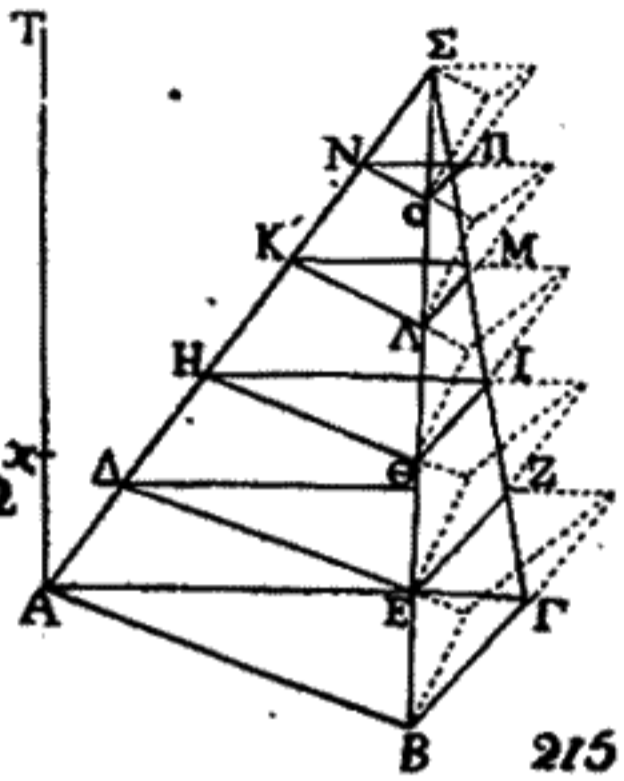
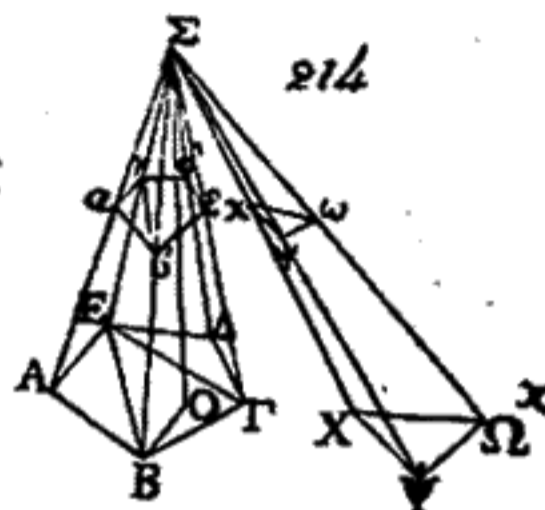
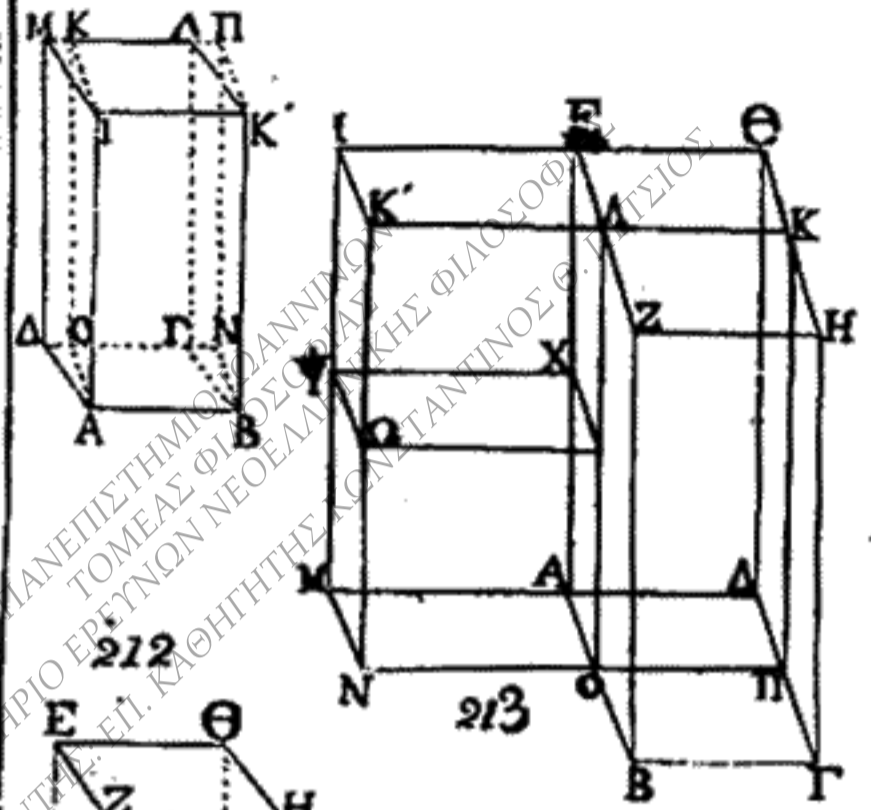

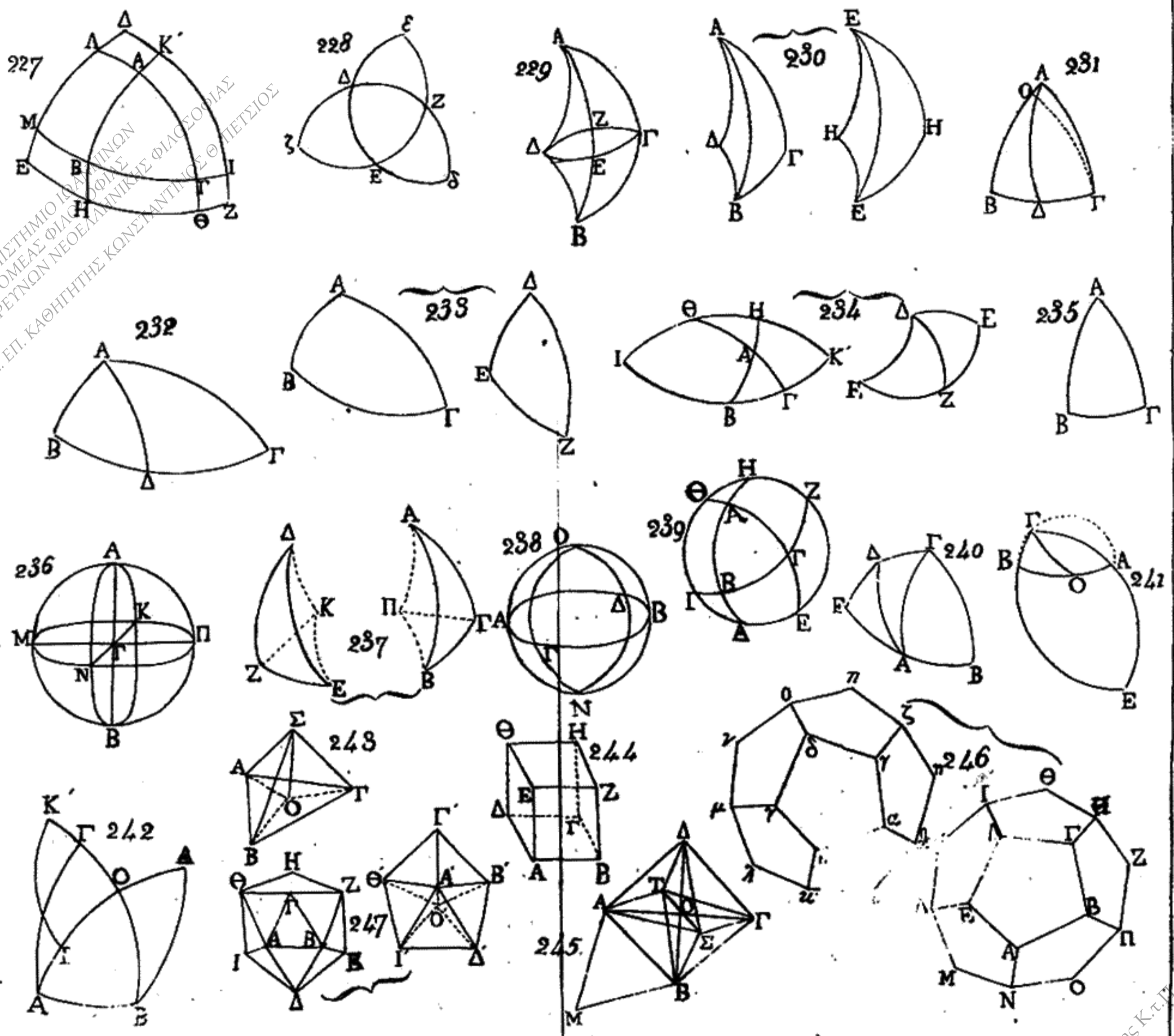

ΠΑΝΕΠΙΣΤΗΜΙΟ ΙΩΑΝΝΙΝΩΝ
 ΤΟΜΕΑΣ ΦΙΛΟΣΟΦΙΑΣ
 ΔΙΕΥΘΥΝΤΗΣ: ΕΠ. ΚΑΘΗΓΗΤΗΣ ΚΩΝΣΤΑΝΤΙΝΟΣ Θ. ΠΙΤΣΙΟΣ

ΠΑΝΕΠΙΣΤΗΜΙΟ ΙΩΑΝΝΙΝΩΝ
ΤΟΜΕΑΣ ΦΙΛΟΣΟΦΙΑΣ
ΔΙΕΥΘΥΝΤΗΣ: ΔΗΜΗΤΡΙΟΣ ΚΑΘΗΓΗΤΗΣ ΚΩΝΣΤΑΝΤΙΝΟΥ Θ. ΠΕΤΣΙΟΣ

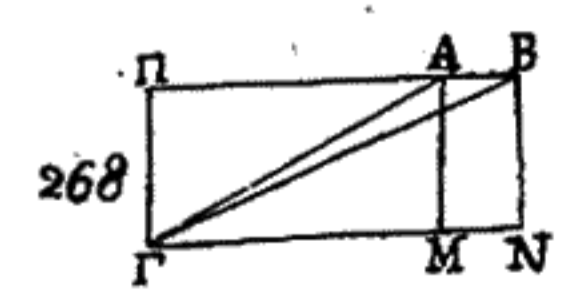
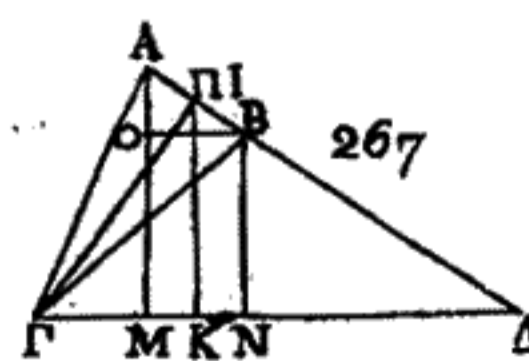
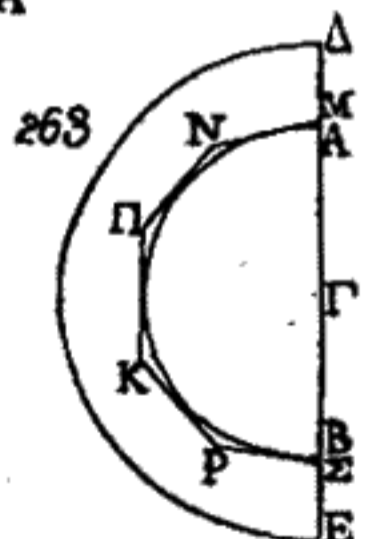
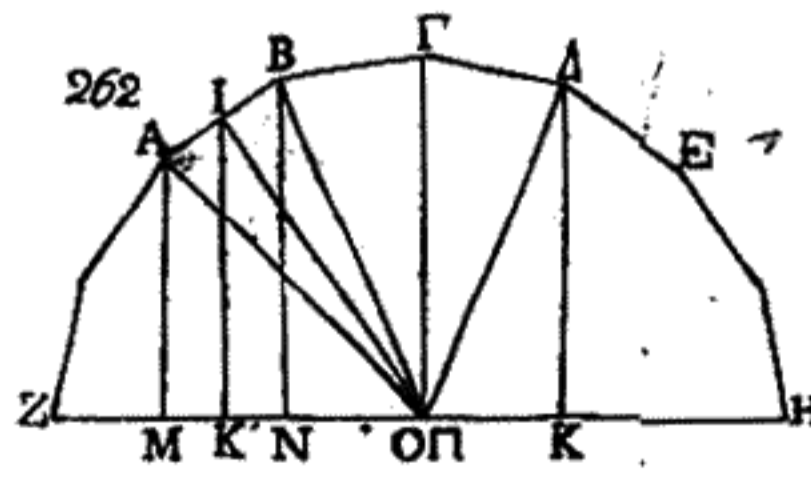
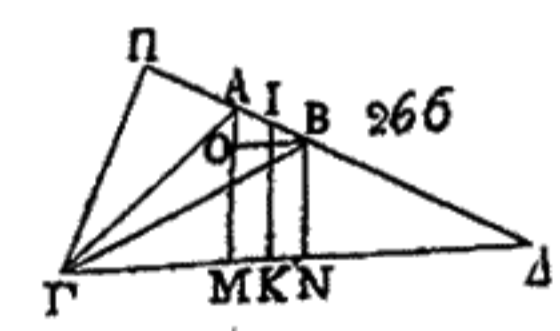
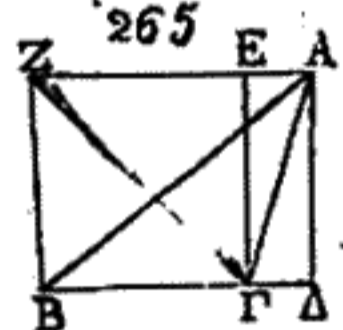
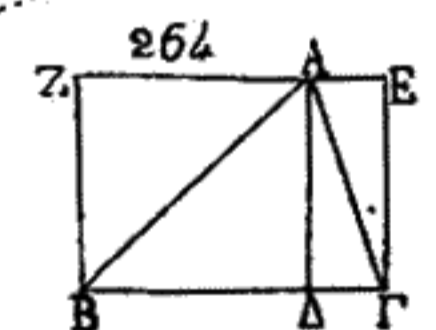
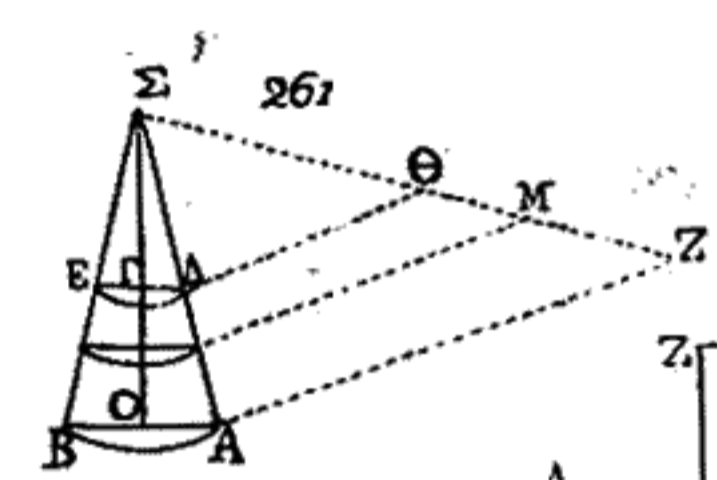
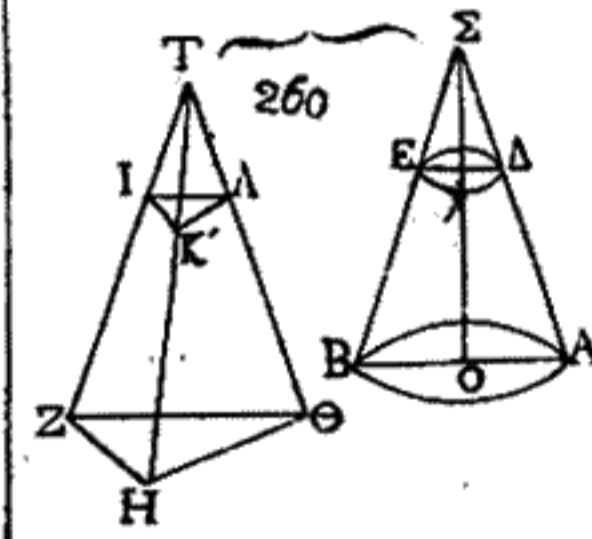
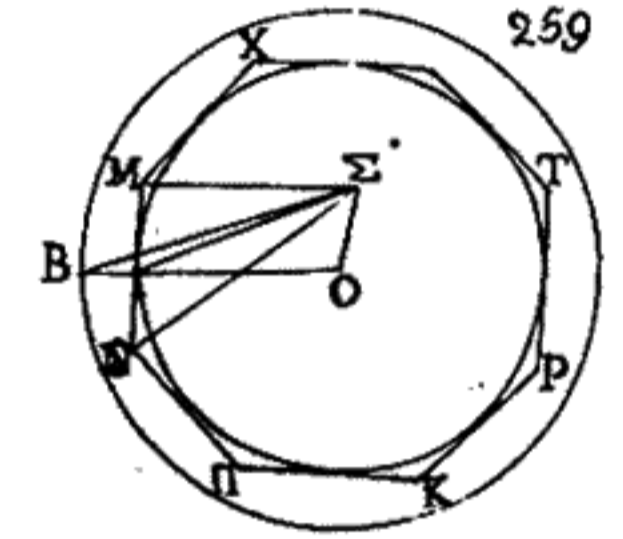
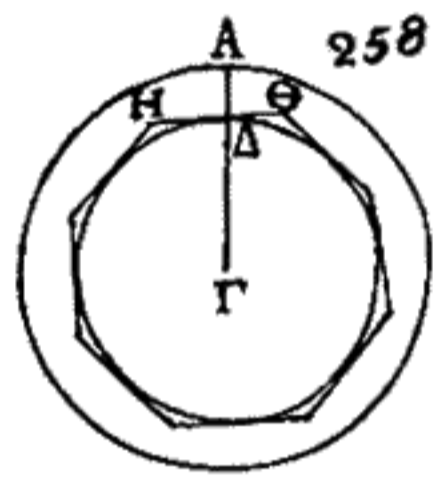
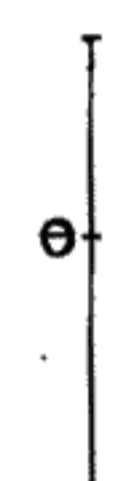
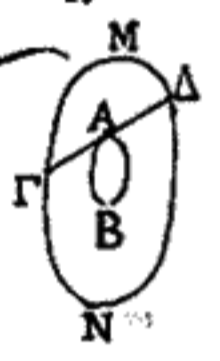
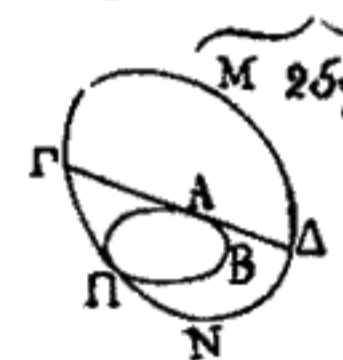
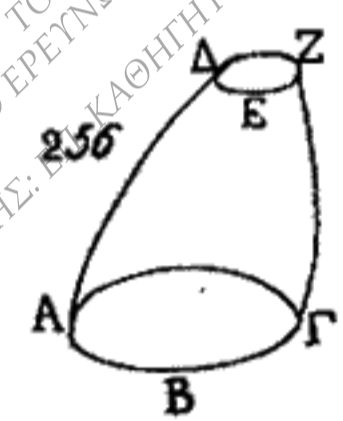
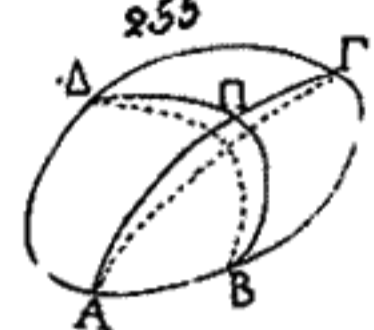
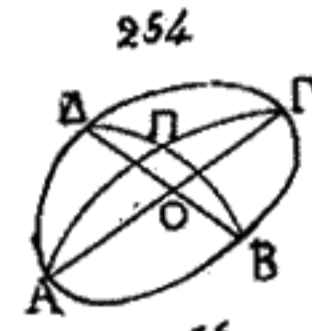
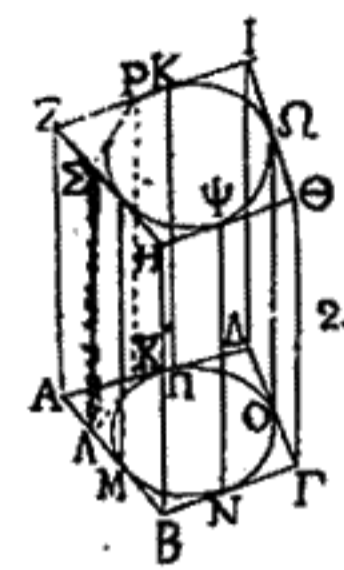
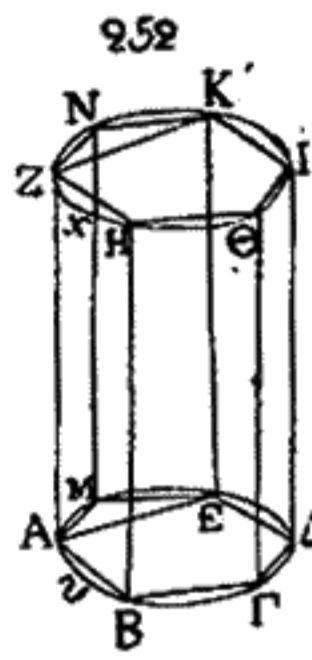
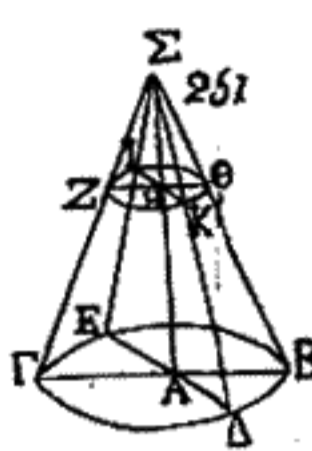
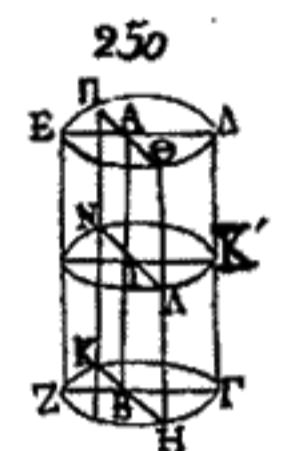
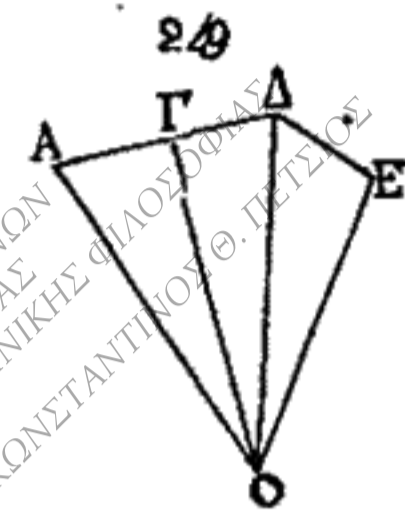
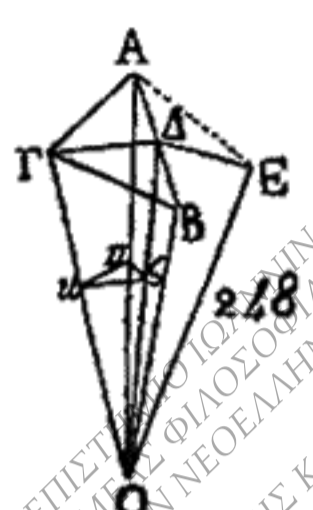

Ε.Υ.Δ. ΤΗ.Κ.Υ. ΙΩΑΝΝΙΝΑ 2006

ΠΑΝΕΠΙΣΤΗΜΙΟ ΙΩΑΝΝΙΝΩΝ
ΤΟΜΕΑΣ ΦΙΛΟΣΟΦΙΑΣ
ΕΡΓΑΣΤΗΡΙΟ ΕΡΕΥΝΩΝ ΝΕΟΕΛΛΗΝΙΚΗΣ ΦΙΛΟΣΟΦΙΑΣ
ΔΙΕΥΘΥΝΤΗΣ: ΕΠ. ΚΑΘΗΓΗΤΗΣ ΚΩΝΣΤΑΝΤΙΝΟΣ ΜΕΤΣΙΟΣ

