

ΠΑΡΟΡΑΜΑΤΑ.

- Σελ. Στοιχοι
- 11 5 Ἀντί καθό ημεδιάμετροι, γράψε καθό ημεδιάμετροι τοῦ κύκλου ΒΓΔ.
- 14 15 ἀντί τέρμων ἀπ' αὐτῆς τὴν $AB = AG$, γρ. τὴν $ΔB = AG$.
- 23 16 ἀντί ἔσω ἢ πλευρὰ $AB > AG$, γρ. $AB > AG$.
- 30 5 ἀντί ὡσε νὰ ἐκτελεσθῇ τρίγ. τὸ ΑΘΙ, γρ. ΗΙΘ
- 43 24 ἀντί περὶ τῆμ διάμετρον AB , γρ. $ΔB$
- 45 20 ἀντί οἶα εἶναι τοῦ ΘΙ, γρ. ΖΙ
- 48 1 ἀντί $ΓΖΔ = \text{παραλ. } \frac{\Lambda Z}{2}$, γρ. $ΓΖΒ = \text{παραλ. } \frac{\Lambda Z}{2}$
- 13 ἀντί $AB^2 = BG^2 + AG^2$, γρ. $AB^2 = BG^2 + AG^2$
- 18 ἀντί $\therefore BG : AG : GK$, γρ. $\therefore BG : AG : GK$
- — ἀντί τὸ δ' ὀρθογ. AZ , γρ. εἰς δὲ τὸ ὀρθογ. AZ
- 61 16 ἀντί ἔσω AB ἢ δοθεῖσα εὐθεῖα, γρ. ἔσω AB ἢ δοθεῖσα εὐθεῖσα οἶχα τετμημένη κατὰ τὸ Γ.
- 62 28 ἀντί $EA^2 = AB^2 + EA^2$, γρ. $EA^2 = AB^2 + EA^2$
- 63 28 ἀντί τότε $2(3 - \sqrt{5}) = (\sqrt{5} - 1)$, γρ. $2(3 - \sqrt{5}) = (\sqrt{5} - 1)^2$
- 64 20 ἀντί $AB^2 + ΔB^2 = 2AB^2 + ΔΔ^2$, γρ. $AB^2 + ΔB^2 = 2AB^2 + ΔΔ^2$
- 72 3 ἀντί δ' ὅτι ἢ $αE = εΘ$, γρ. δ' ὅτι ἢ $αE = αΘ$, εἴτε τοξ. $BE = \text{τοξ. } BΘ$
- 91 27 ἀντί ἂν εἰς τρίγωνον ληφθῇ, γρ. ἂν εἰς ὀρθογώνιον τρίγωνον.

Σελ. Στοιχοι.

109 6 ἀντι ἐπειδὴ $B\Delta = AB \times B\Gamma$, γρ. $B\Delta = AB \times B\Gamma$.

123 3 ἀντι εἰς τὴν ἐξῆς $A : A\epsilon :: \Gamma : \Gamma\mu$, γρ. $A : \Delta\delta :: \Gamma : \Gamma\mu$.

135 15 ἀντι εἴτε $\frac{20-1}{5} > \frac{12-1}{4}$, γρ. εἴτε $\frac{20}{5} - 1 > \frac{12}{4} - 1$.

143 12 ἀντι ἔξω $\Gamma\Delta : \epsilon\Lambda :: AB : \Delta B$, γρ. $\Gamma\Delta : \Delta B :: \epsilon\Lambda : AB$.

154 23 ἀντι πορ. α'. πρ. κ', γρ. πορ. α'. πρ. η'.

157 23 ἀντι εἴτε τριγ. $\alpha\Gamma\beta : \text{τριγ. } M :: \beta\Gamma : \Gamma\alpha$, γρ. τριγ. $A\beta\Gamma : \text{τριγ. } M :: \beta\Gamma : \Gamma A$.

166 20 ἀντι εἴτε $= 3 A\Gamma = \Lambda K$, γρ. εἴτε $3 A\Gamma \times AK$.

176 19 ἀντι ἐπ' εὐθείας (ἢ $A\Delta$), γρ. ἐπ' εὐθείας (ἢ $B\Delta$).

196 3 ἀντι εἶναι ὀρθαί (πορ. β'. πρ. α'), γρ. εἶναι ὀρθαί (πορ. β'. πρ. δ').

199 6 ἀντι ὡσε δύο εὐθεῖαι $B\epsilon, \Gamma\Delta$, γρ. ὡσε αἱ δύο εὐθεῖαι $B\epsilon, \Gamma\lambda$.

217 28 ἀντι $KI : \Omega P :: \Omega M : HK$, γρ. $KI : \Omega P :: \Pi\Omega : HK$.

224 14 ἀντι ἢ ἂν μιᾶς τῶν πλευρῶν, γρ. ἢ ἂν μιᾶς τῶν πλευρῶν τριγώνου τινος.

234 2 ἀντι τότε καὶ ἐπιπ. $E\eta Z = \epsilon\pi\pi. P\Pi\Omega$, γρ. τότε $E\eta Z = B\Pi\Omega$.

250 3 ἀντι αἱ βάσεις καὶ τὰ ὕψη αὐτῶν εἶναι ἴσα, γρ. αἱ βάσεις καὶ τὰ ὕψη αὐτῶν ἀντιπᾶσχουσι.

ΒΙΒΛΙΔΑ ΣΧΗΜΑΤΑ

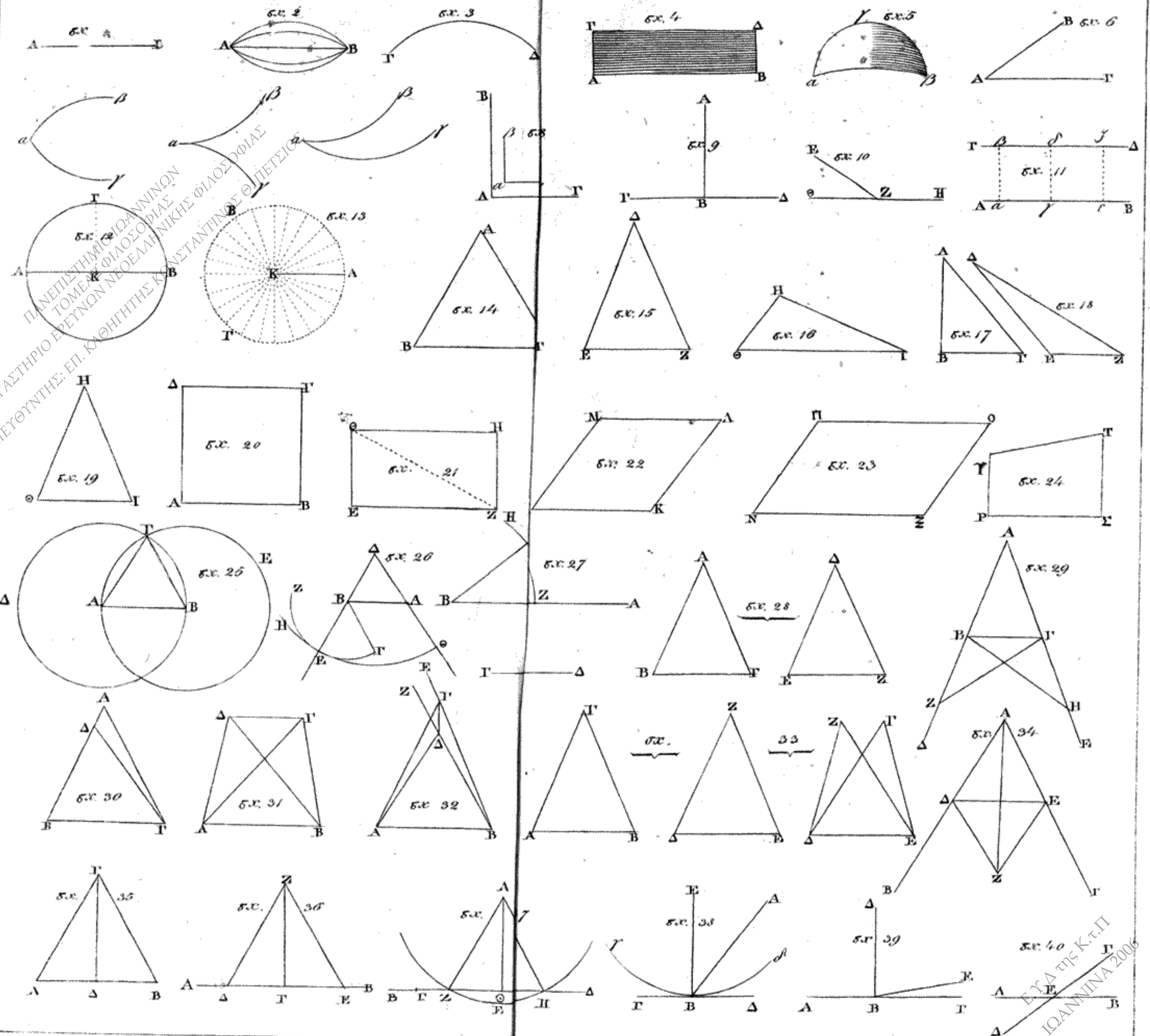

ΠΑΝΕΠΙΣΤΗΜΙΟ ΙΩΑΝΝΙΝΩΝ
 ΤΟΜΕΑΣ ΦΙΛΟΣΟΦΙΑΣ
 ΕΡΓΑΣΤΗΡΙΟ ΕΡΕΥΝΩΝ ΝΕΟΕΛΛΗΝΙΚΗΣ ΦΙΛΟΣΟΦΙΑΣ
 ΔΙΕΥΘΥΝΤΗΣ: ΕΠ. ΚΑΘΗΓΗΤΗΣ ΚΩΝΣΤΑΝΤΙΝΟΣ Θ. ΠΕΤΣΙΟΣ

ΕΡΓΑ ΤΗΣ Κ.Α.Π.
 ΙΩΑΝΝΙΝΑ 2006

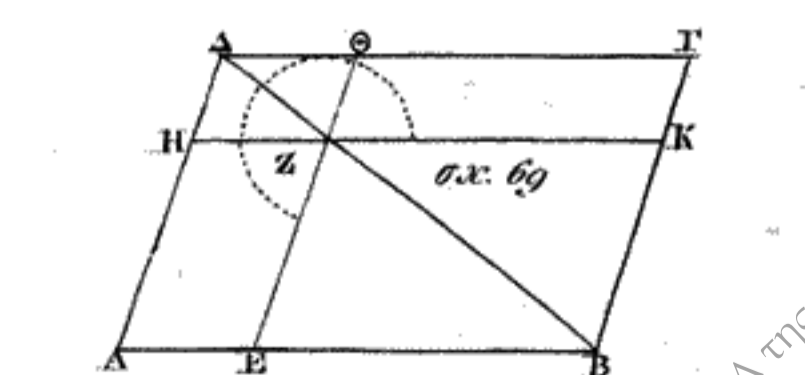
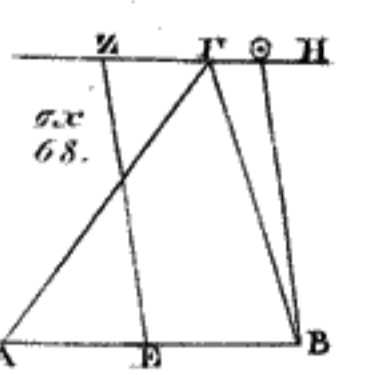
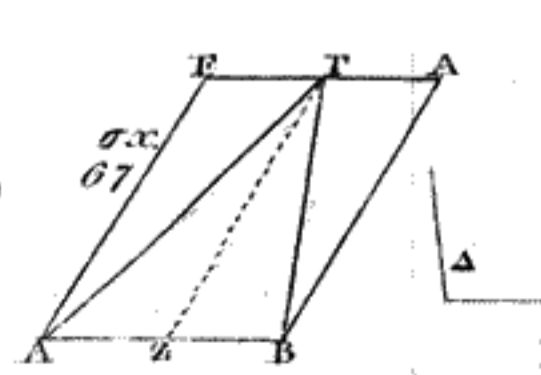
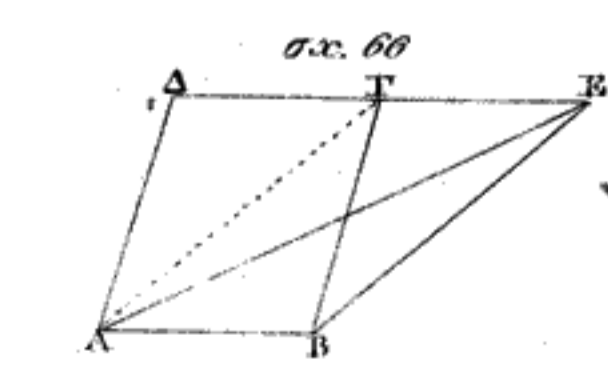
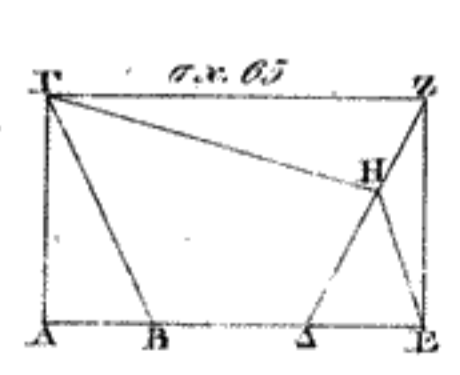
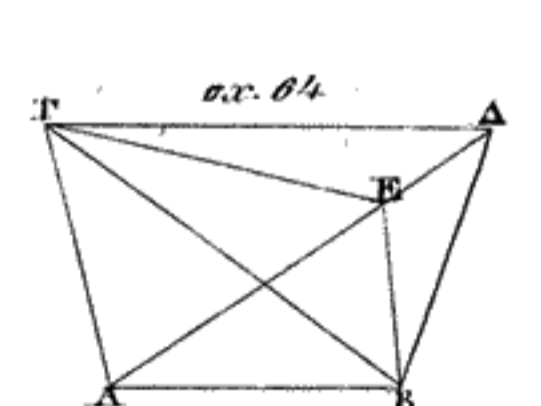
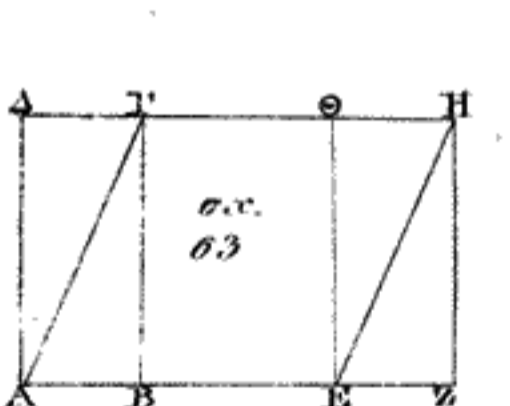
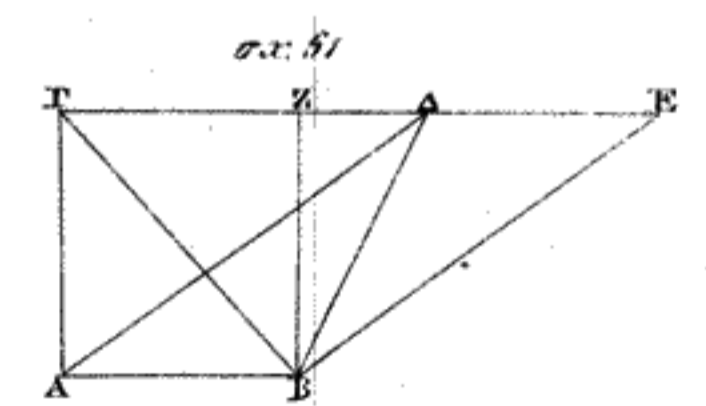
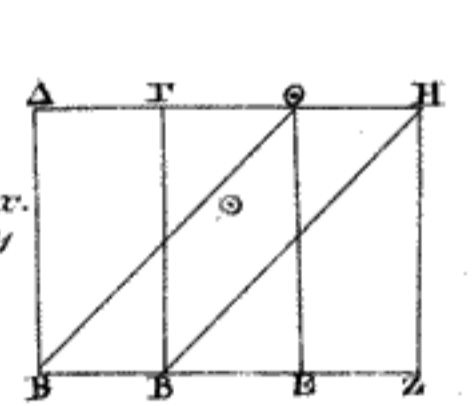
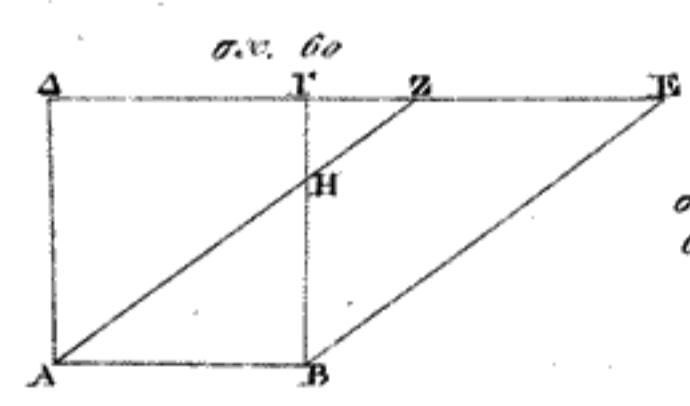
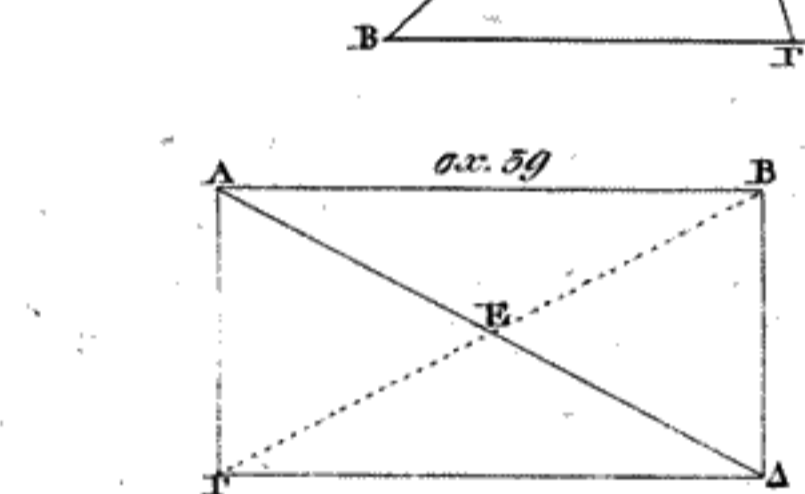
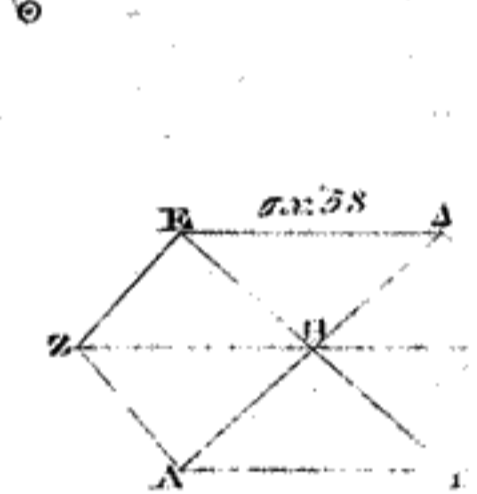
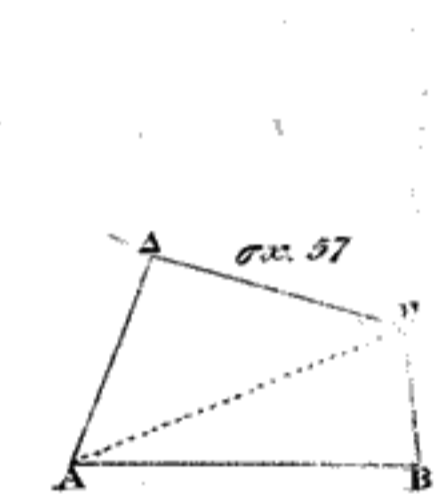
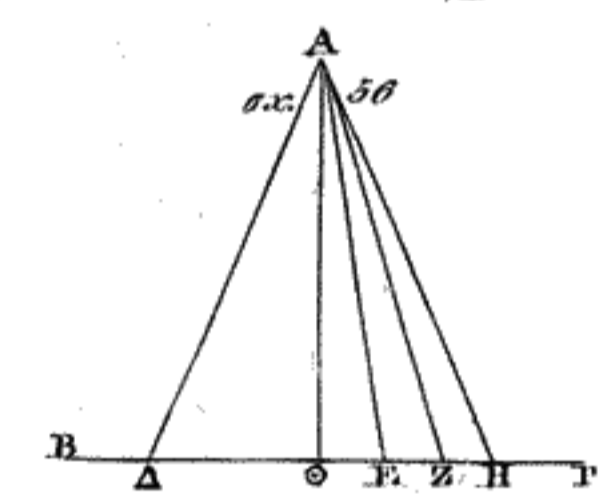
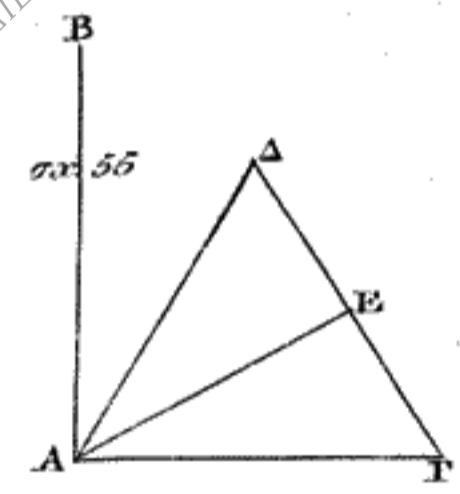
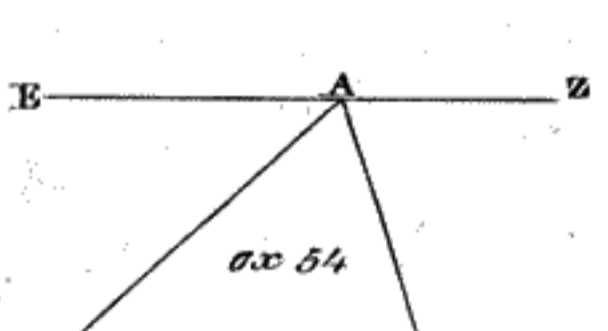
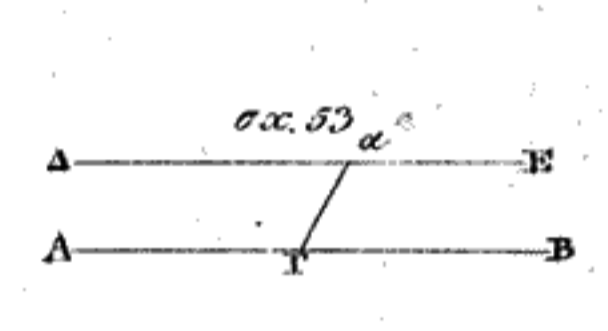
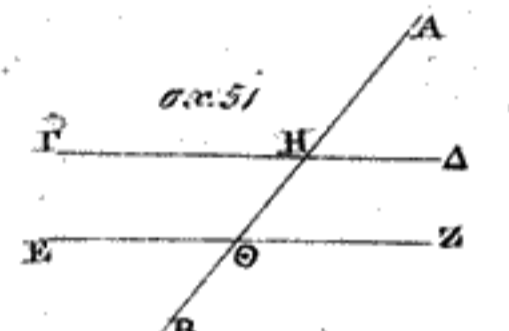
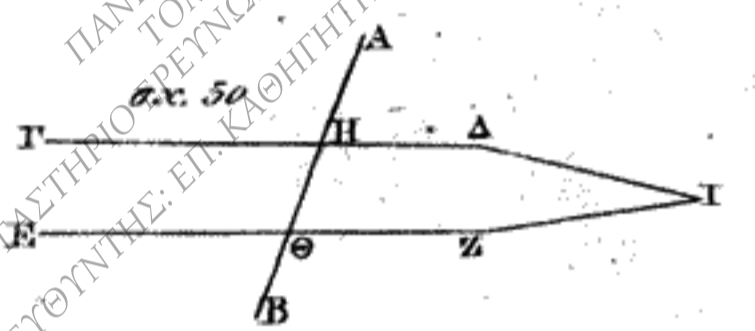
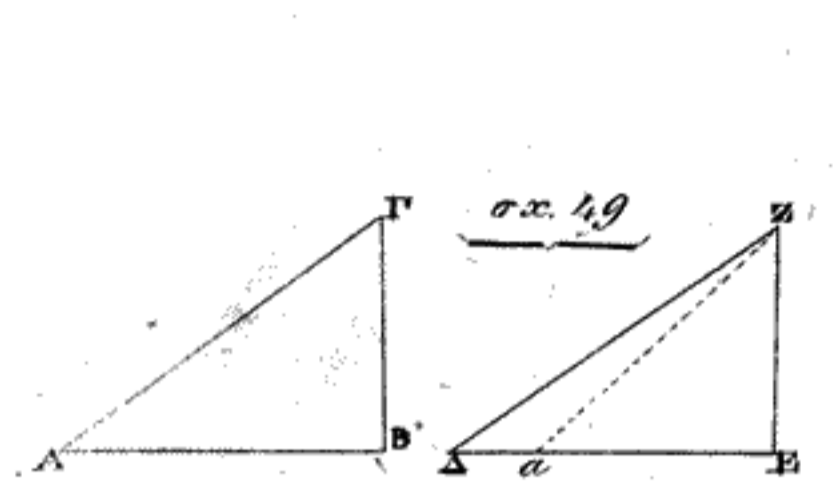
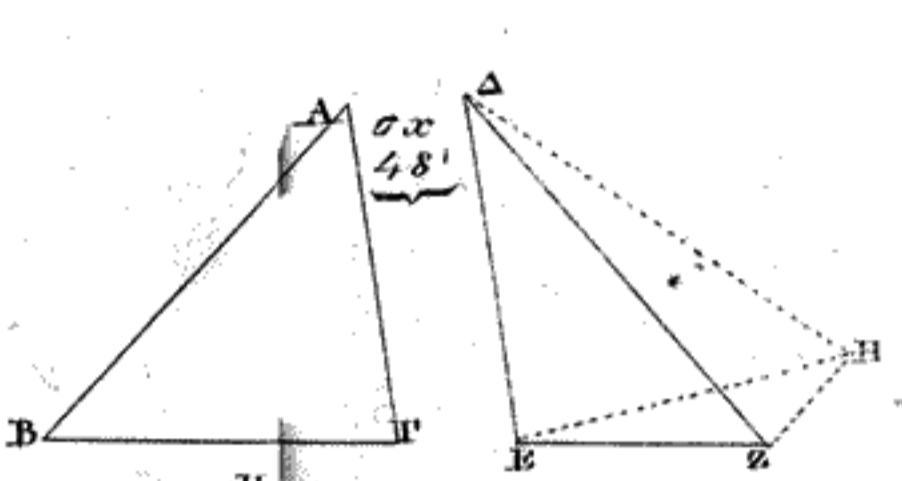
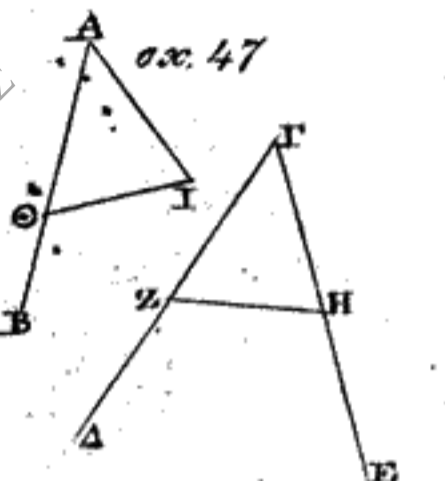
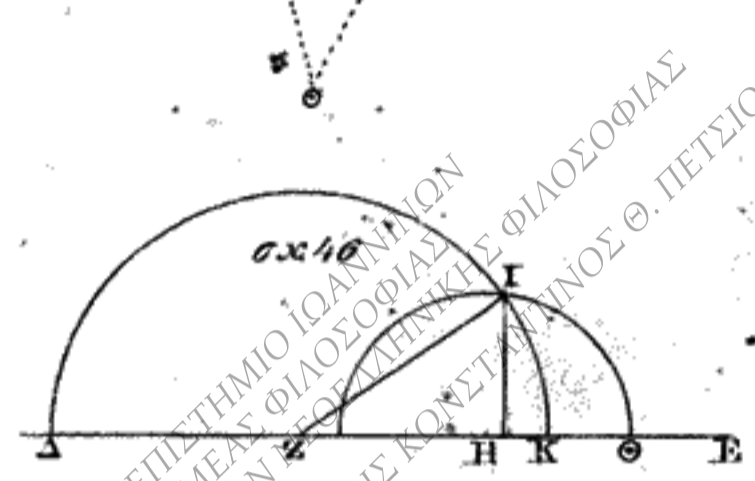
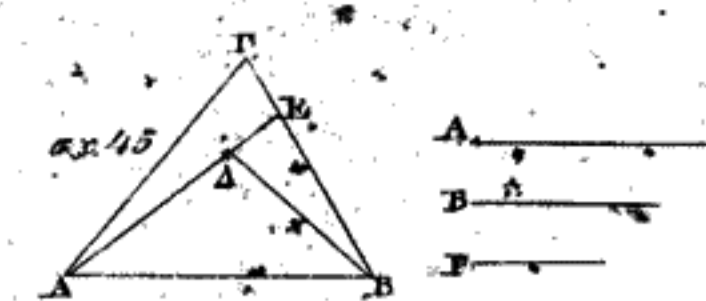
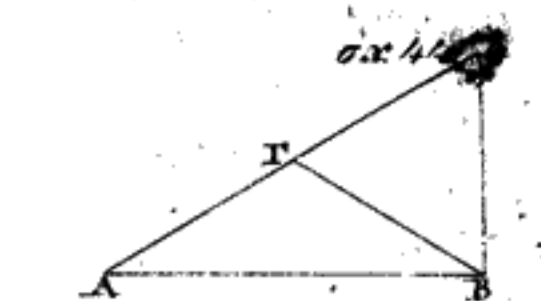
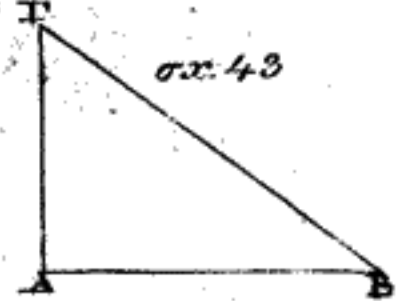
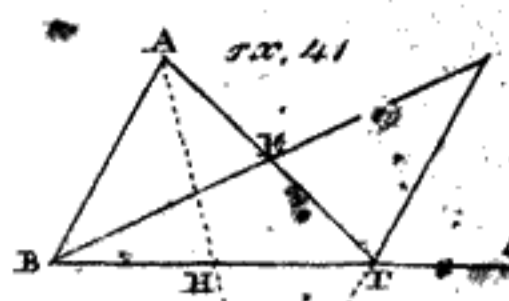

ΠΑΝΕΠΙΣΤΗΜΙΟ ΙΩΑΝΝΙΝΩΝ
 ΤΟΜΕΑΣ ΦΙΛΟΣΟΦΙΑΣ
 ΕΡΓΑΣΤΗΡΙΟ ΜΕΤΕΤΕΡΩΝ ΕΠΙΣΤΗΜΩΝ
 ΔΙΕΥΘΥΝΤΗΣ: ΕΠ. ΚΑΘΗΓΗΤΗΣ ΚΩΝΣΤΑΝΤΙΝΟΣ Θ. ΠΕΤΣΙΟΣ

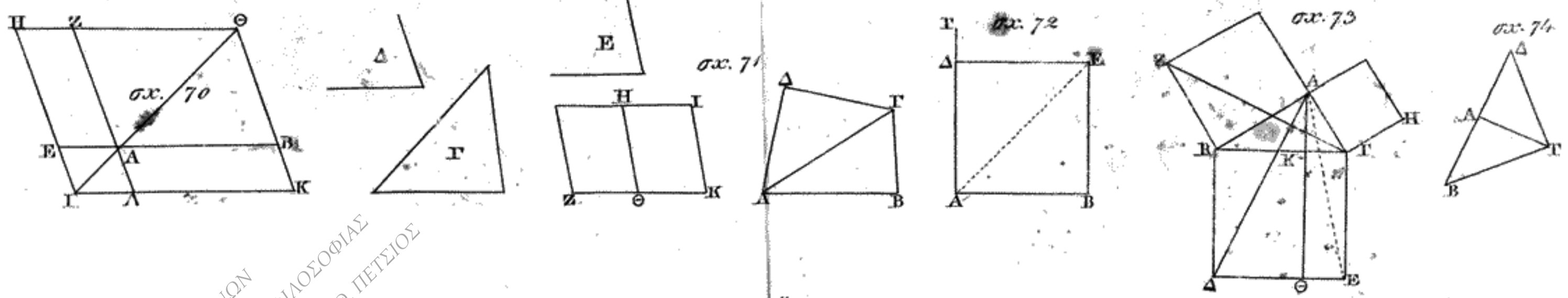

ΒΙΒΛΙΟ Β ΣΧΗΜΑΤΑ

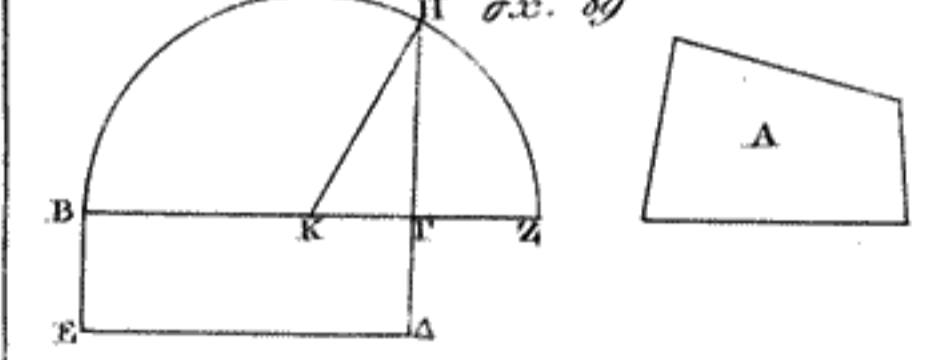
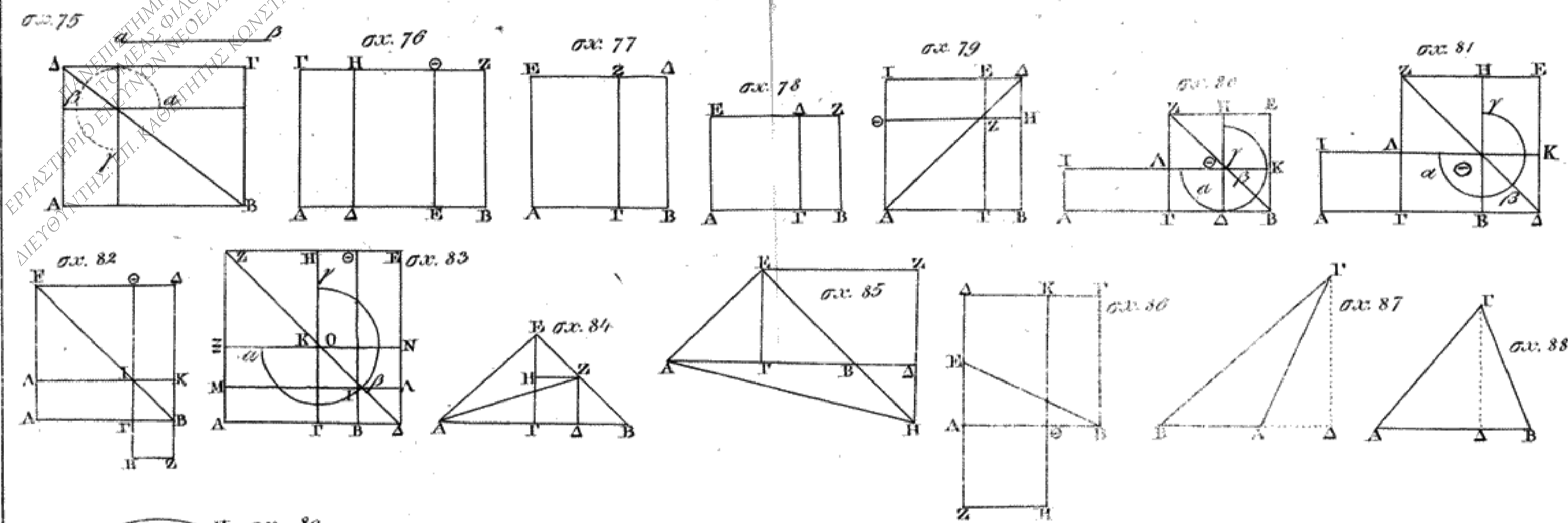

ΒΙΒΛΙΟ Γ ΣΧΗΜΑΤΑ

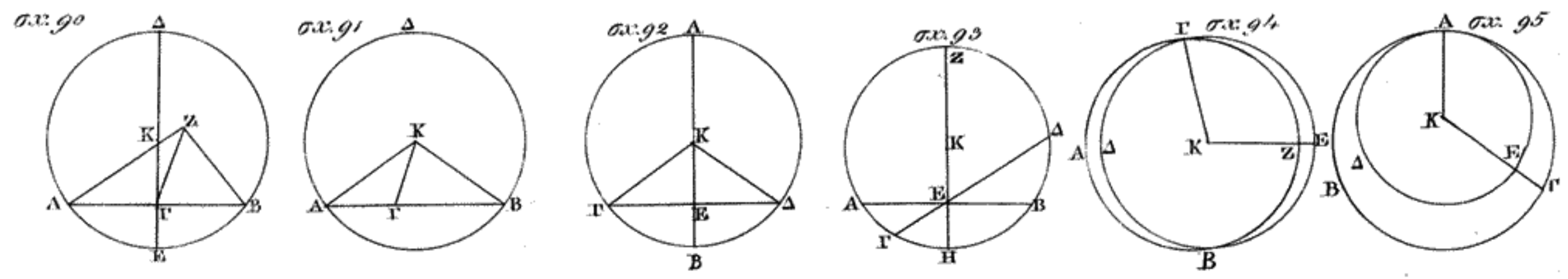

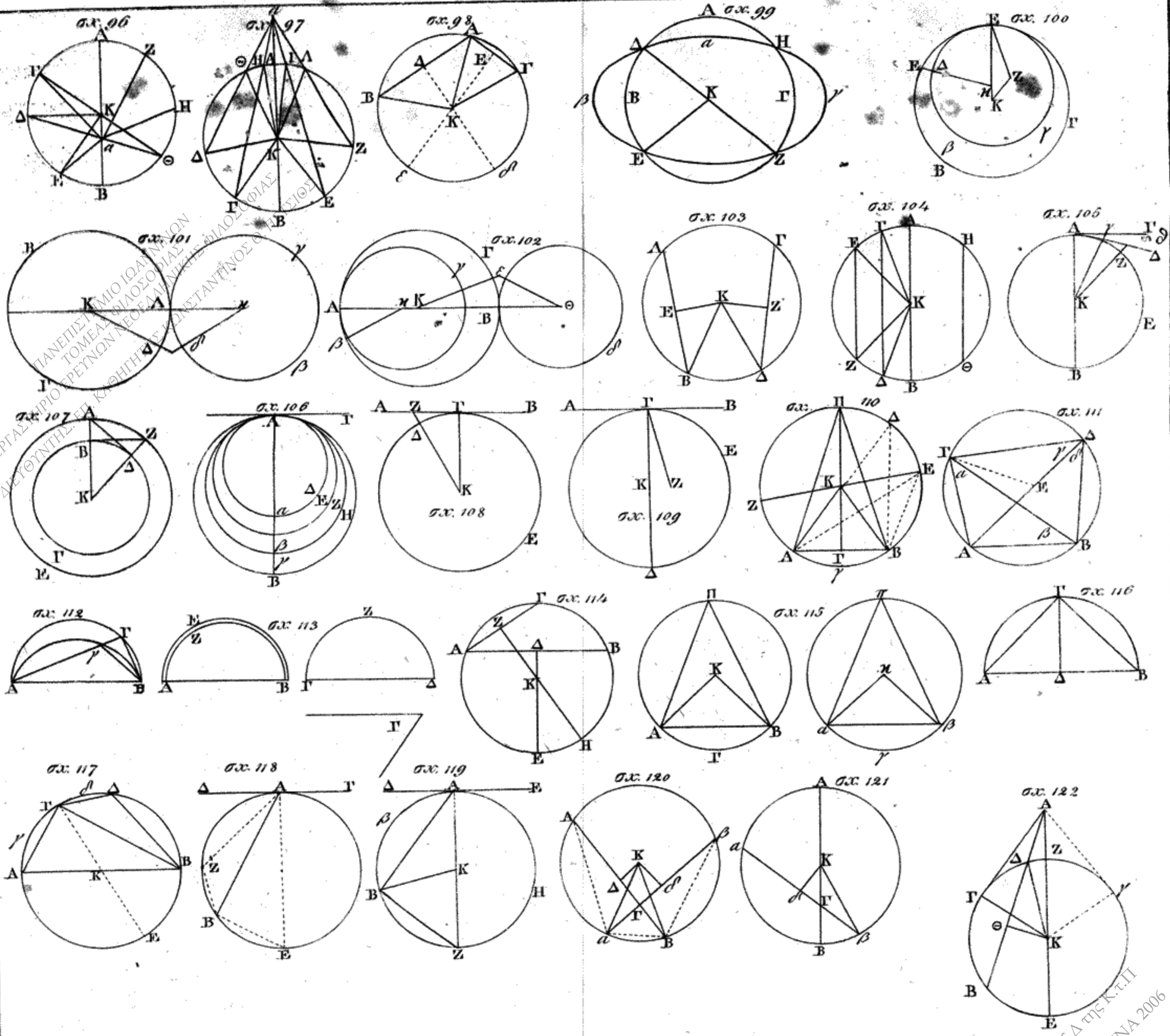

ΕΡΤΑΞΙΜΙΟ ΙΩΑΝΝΙΝΩΝ
 ΤΟΜΕΑΣ ΦΙΛΟΣΟΦΙΑΣ
 ΔΕΥΤΕΡΟ ΕΤΟΣ ΚΑΘΗΜΕΡΕΣ ΚΩΝΣΤΑΝΤΙΝΟΣ Ο ΜΕΓΑΛΟΣ

ΒΙΒΛΙΣ Δ' ΣΧΗΜΑΤΑ

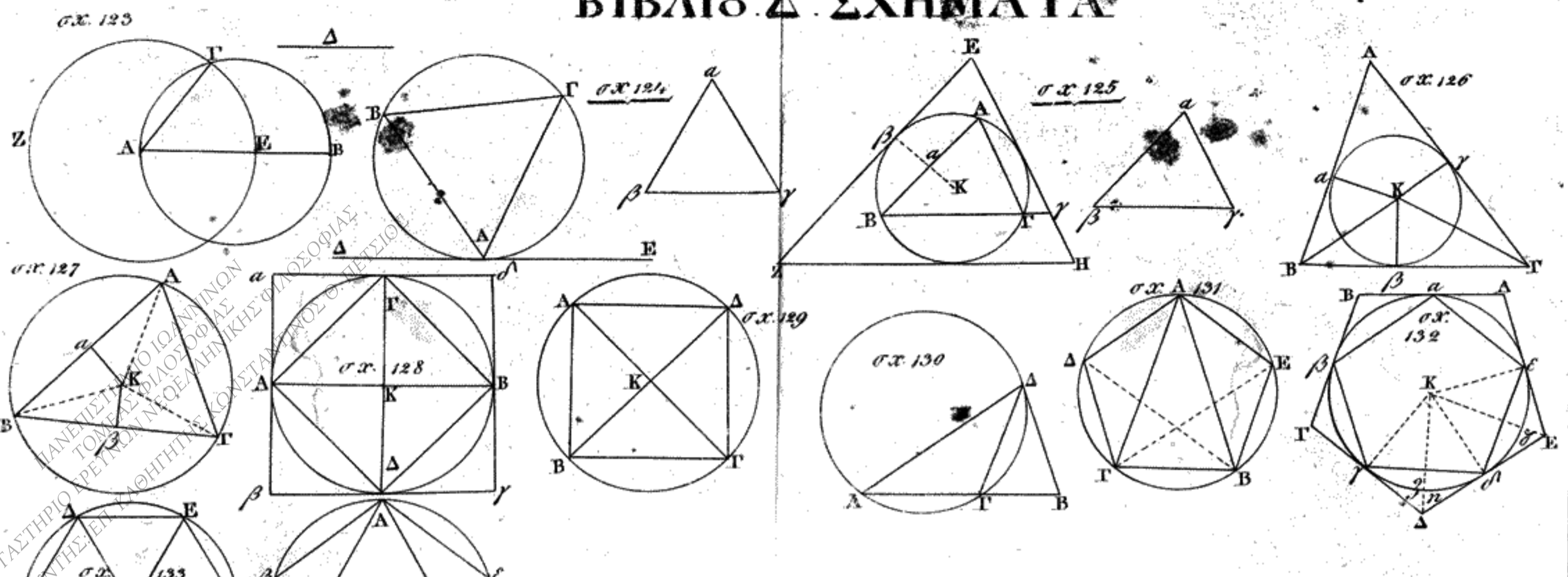

ΒΙΒΛΙΣ Ε' ΣΧΗΜΑΤΑ

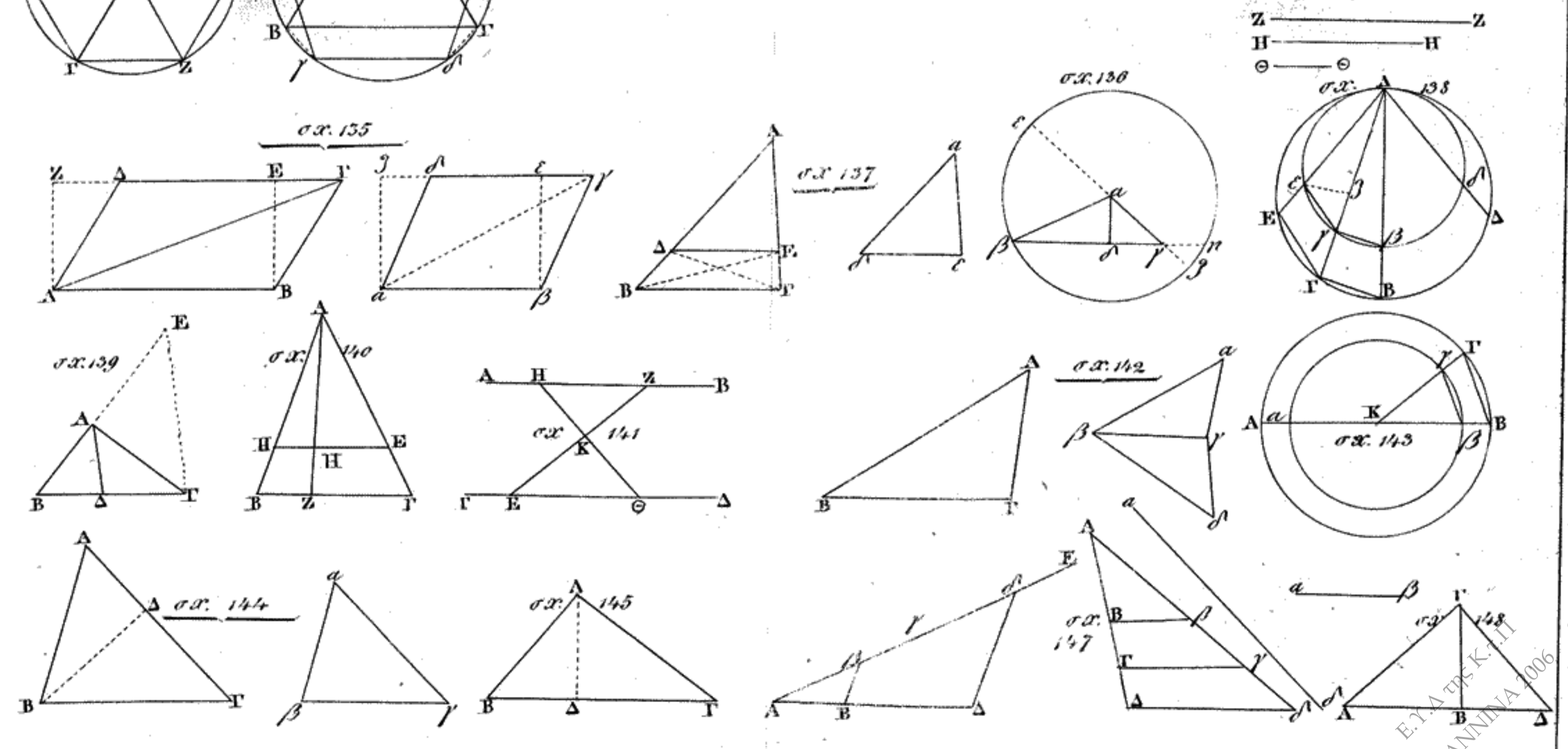

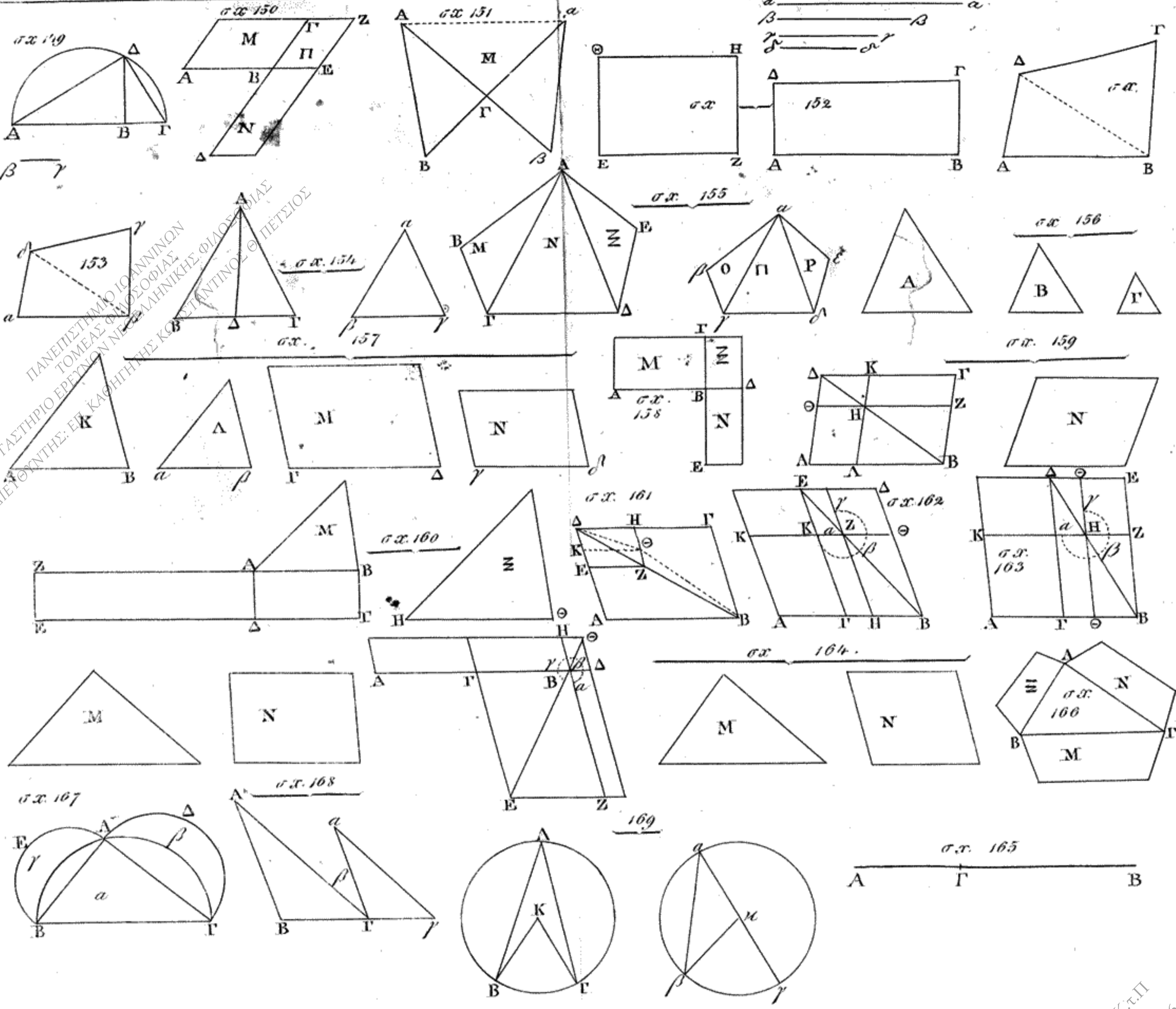

ΠΑΝΕΠΙΣΤΗΜΙΟ ΙΟΑΝΝΙΝΩΝ
 ΤΟΜΕΑΣ ΦΙΛΟΣΟΦΙΑΣ
 ΔΙΕΥΘΥΝΤΗΣ: ΕΠ. ΚΑΘΗΓΗΤΗΣ ΚΩΝΣΤΑΝΤΙΝΟΣ Θ. ΠΙΤΣΙΟΣ

ΒΙΒΛΙΣ ΙΑ ΣΧΗΜΑΤΑ

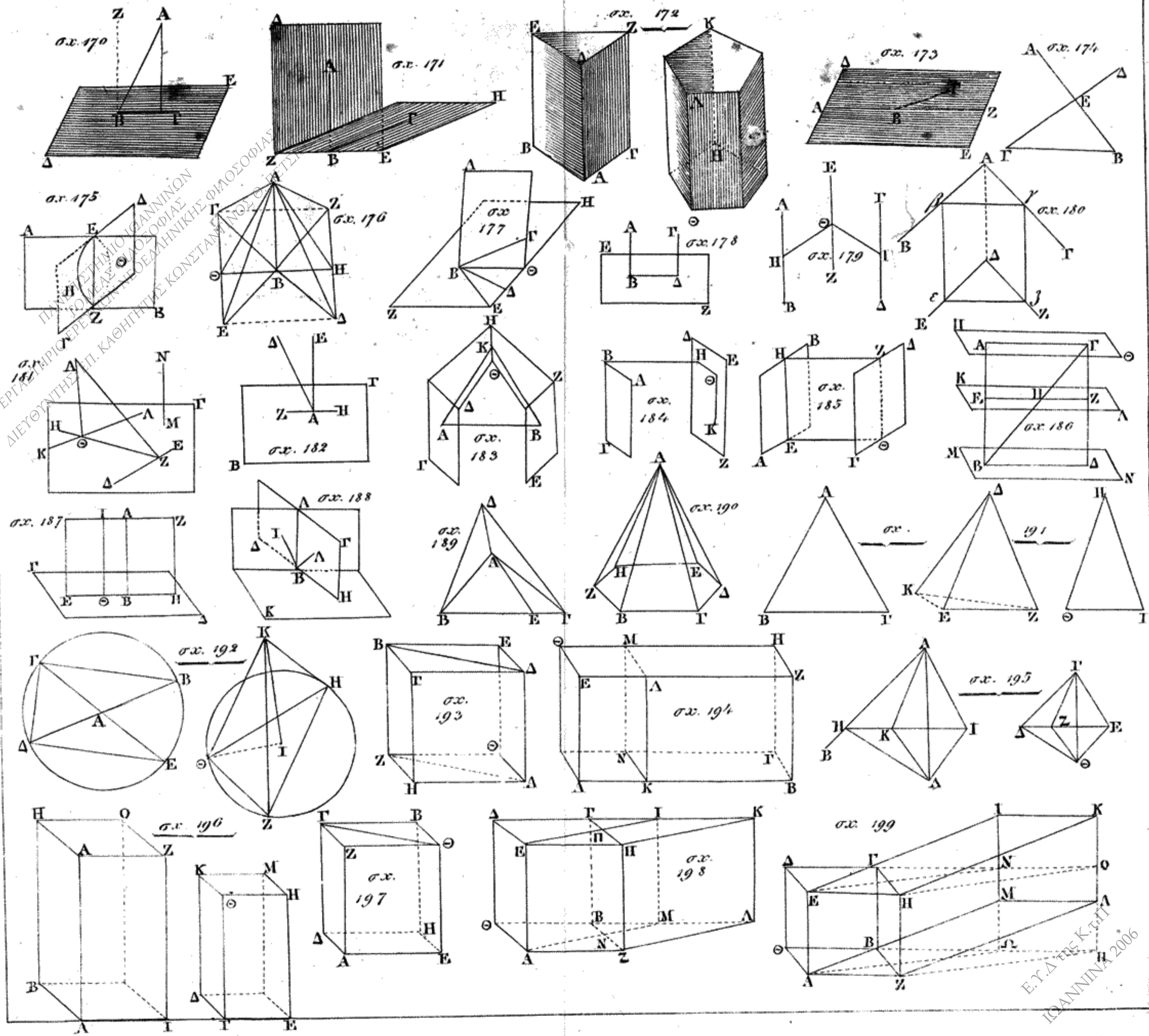

ΠΑΝΕΠΙΣΤΗΜΙΟ ΙΩΑΝΝΙΝΩΝ
 ΙΝΣΤΙΤΟΥΤΟ ΜΕΛΕΤΩΝ ΦΙΛΟΣΟΦΙΑΣ
 ΕΡΓΑΣΤΗΡΙΟ ΕΡΕΥΝΑΣ ΙΣΤΟΡΙΑΣ ΚΑΙ ΕΠΙΣΤΗΜΟΛΟΓΙΑΣ
 ΔΙΕΥΘΥΝΤΗΣ ΔΡ. ΚΑΘΗΓΗΤΗΣ ΚΩΝΣΤΑΝΤΙΝΟΣ ΟΥΡΟΥΤΣΗΣ

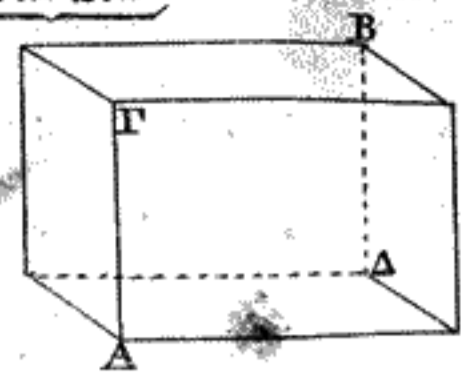
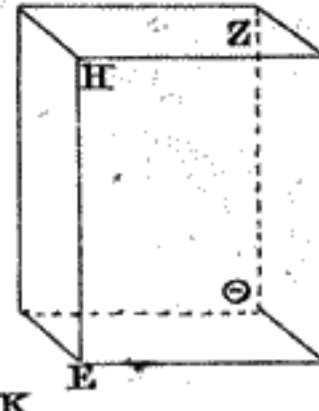
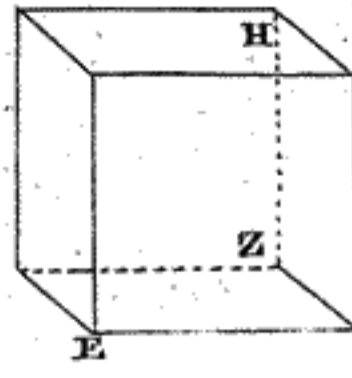
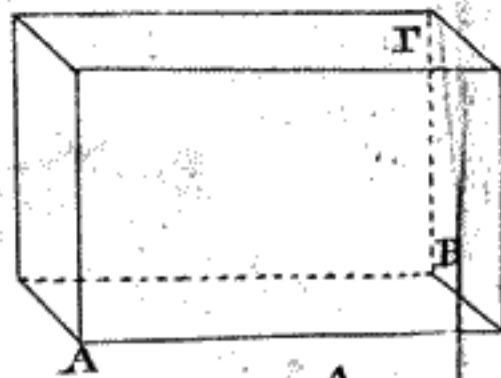
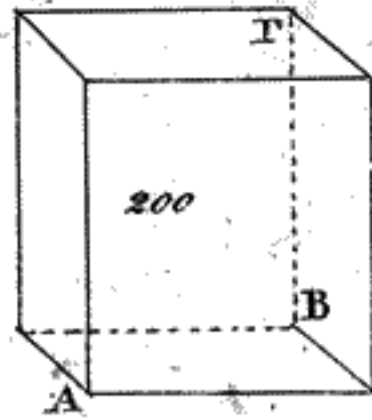
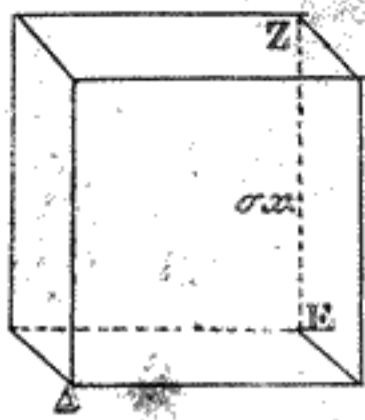

σ. 201

σ. 202

A
B
Γ

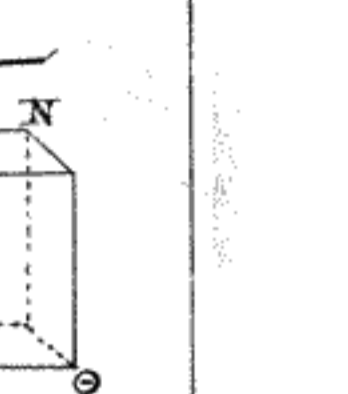
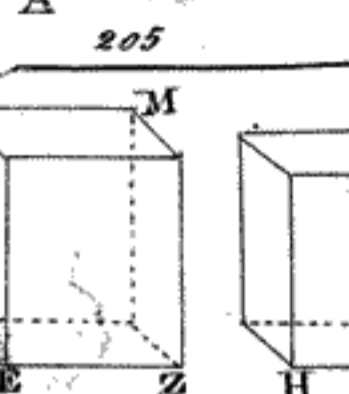
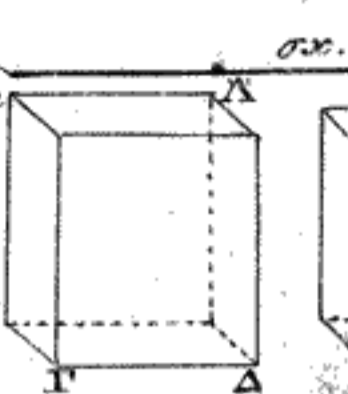
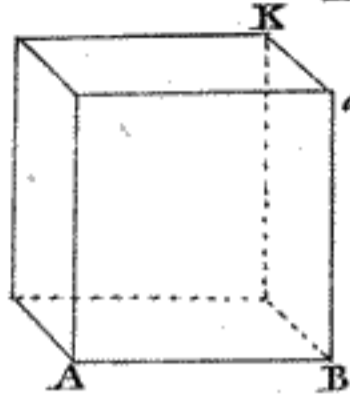
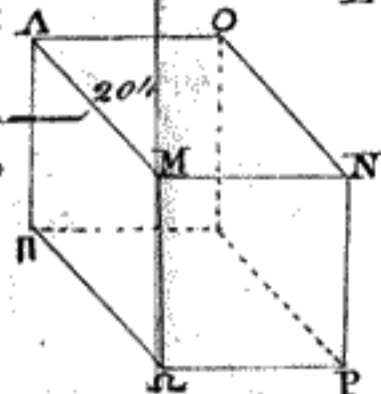
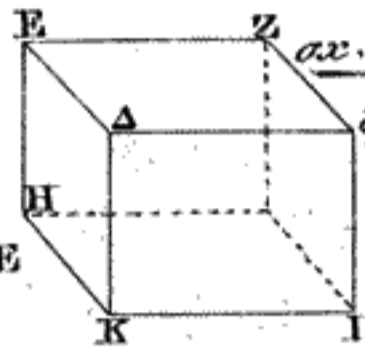

σ. 205

σ. 203

σ. 204

σ. 208

σ. 206

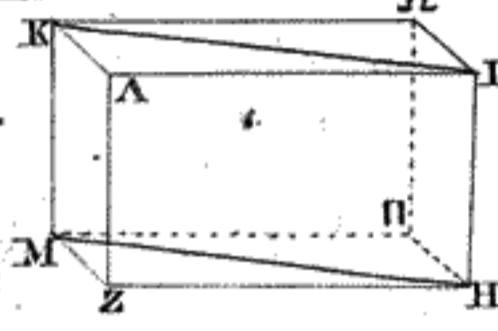
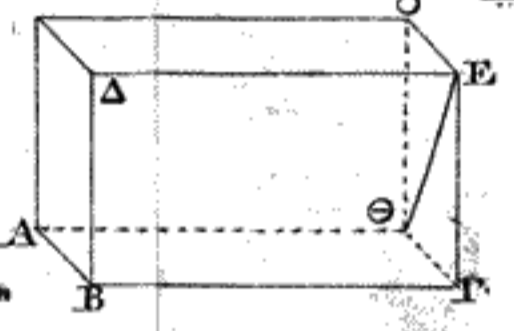
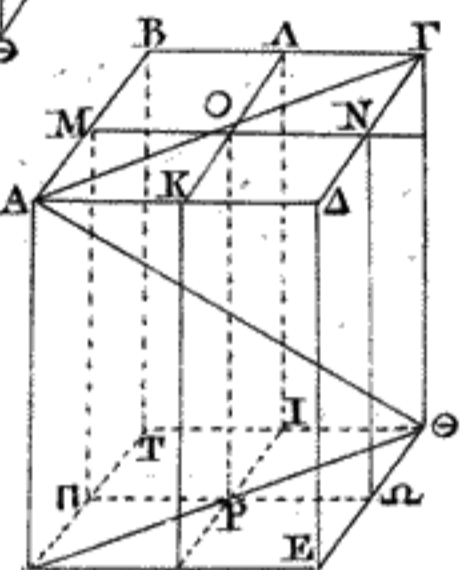
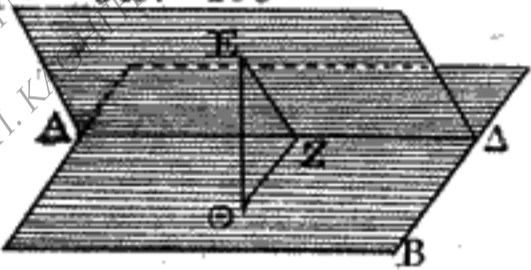

ΒΙΒΛΙΣ ΙΒ ΣΧΗΜΑΤΑ

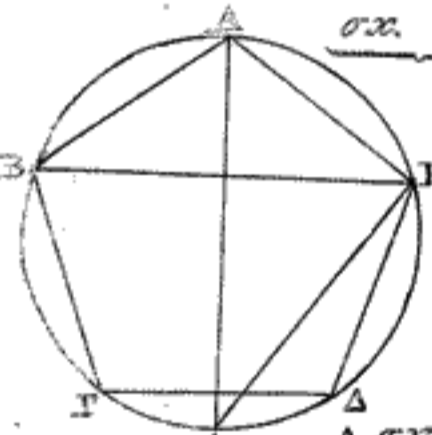

σ. 209

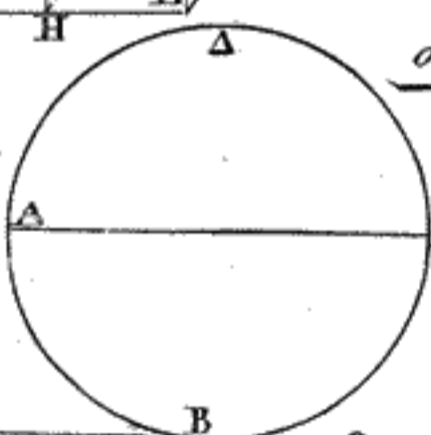
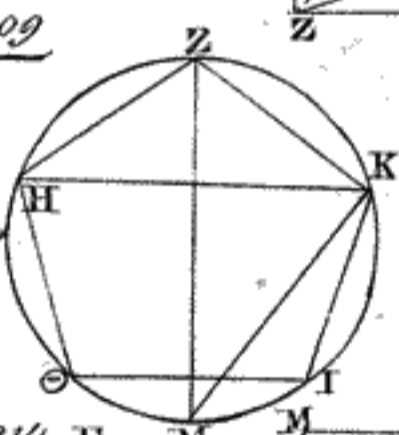

σ. 210

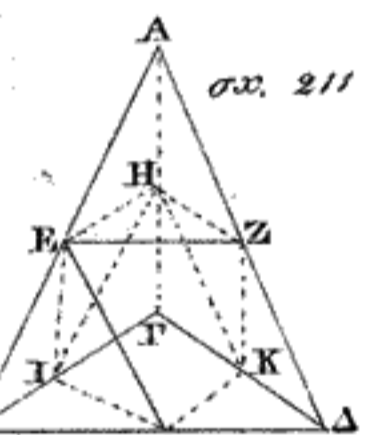
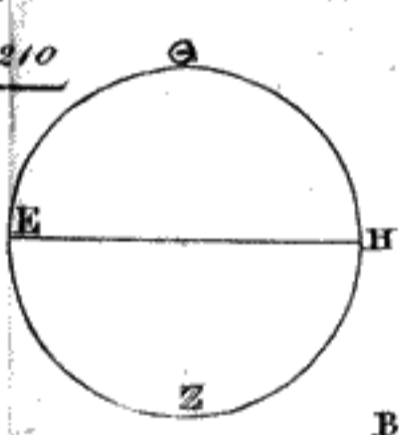

σ. 211

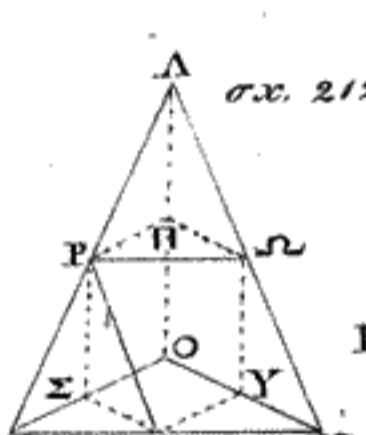

σ. 212

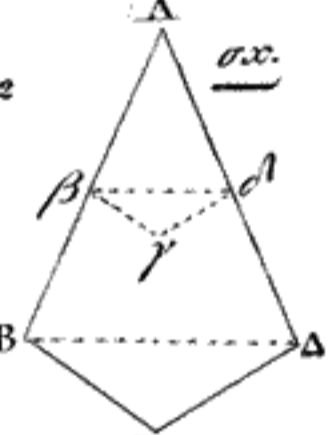

σ.

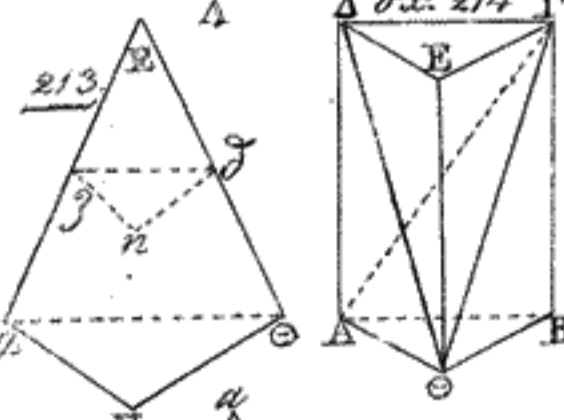

213



σ. 214

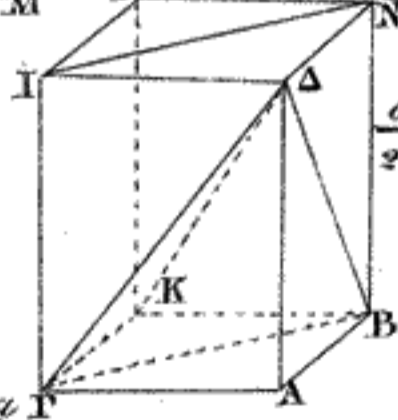

σ. 215

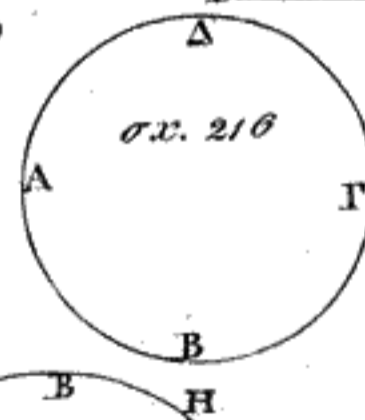
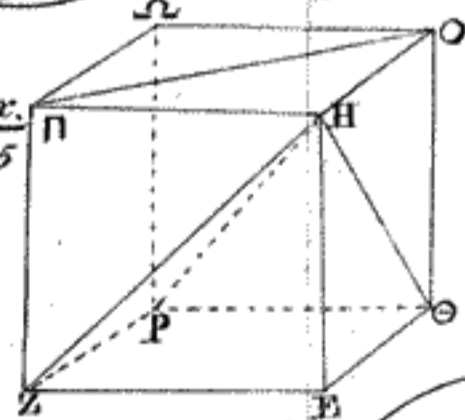

σ. 216

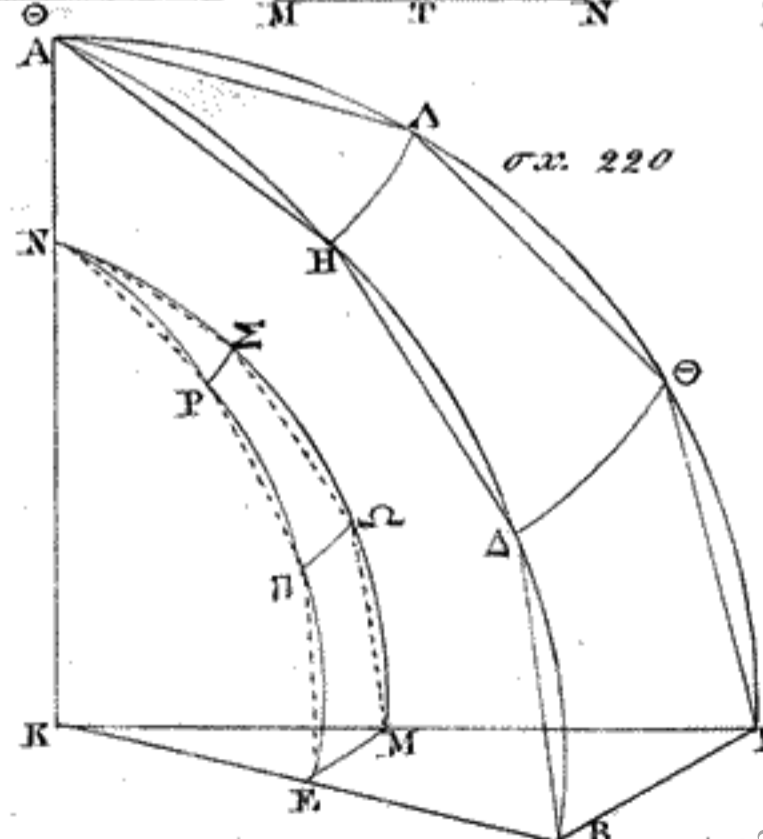

σ. 220

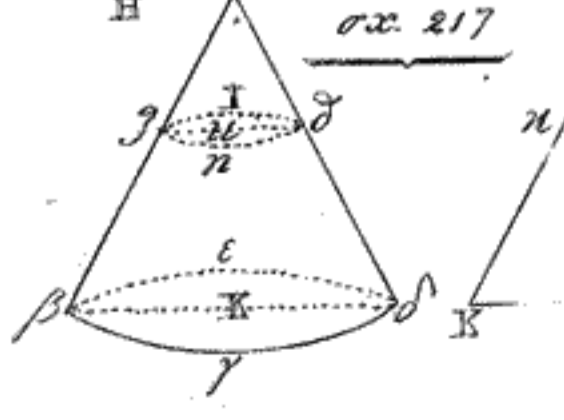

σ. 217

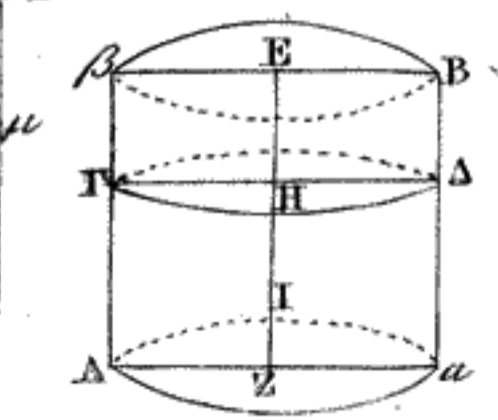

σ. 218

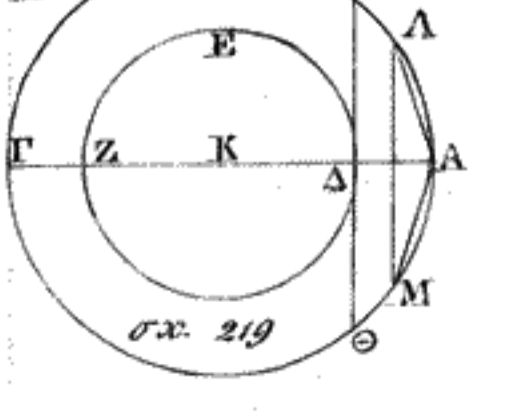

σ. 219