



ΠΑΡΟΡΑΜΑΤΑ.

Σελ. 113.	Στίχ. 11. εἰσί. Γράφ. ὡσι.
118.	16. περαίνεται. Γρ. περαίνει.
122.	19. ἐκτανθείσης. Γρ. ἐκταθείσης.
αὐτ.	22. φαίνεται ὅτι τῷ. Γράφ. φαίνεται. τῷ γάρ.
125.	21. κρφώτερα. Γρ. κρφότερα.
αὐτ.	23. ἀμφοτέραις. Γρ. ἐκατέραις.
131.	22. φέρεται. Γρ. ἴσεται.
αὐτ.	25. περαίνεται ὁ λόγος. Γρ. περαίνου- μεν τὸν λόγον.
132.	28. Τριγωνικῶ κτ. Γρ. Τριγώνω Πρίσ- ματι, ἢ ῥαβδοειδῆ Σωματίῳ.
133.	30. ἀπὸ. Γρ. ὑπὸ.
143.	28. τὰ τριαῦτα. Γρ. ταῦτα τὰ.
144.	26. σιωλελικώτερον. Γρ. σιωλελικώτερος.
147.	16. καὶ ἀλλ. ἄραι. Γρ. ἄραι.
148.	17. ἀνελθόντες. Γρ. ἀνελθόντων.
149.	37. τυ. Γρ. τῶν.
152.	30. τῷ κτ. Γρ. ὃ ἢ Τροχιλαία περι- βαλλεται.
154.	15. τῷ τῷ κτ. Γρ. ὧ ὁ Ἀζων προσ- δέδεται.
156.	24. ἀνόμαλος. Γρ. ἀνώματος.
157.	18. Σχοινίε κτ. Γρ. Σχοινίον τῷ Τρο- χῷ, καὶ τῷ Κυλίνδρῳ.
αὐτ.	23. ἔσης. Γρ. ἔσης.
159.	33. πλωρῶν. Γρ. μέρος.
162.	4. ἀπὸ τῷ. Γρ. τῷ. ὁμοίως καὶ Σελ. 180. 1. καὶ 181. 20. καὶ 234. 18.
αὐτ.	18. καὶ ἀλλ. περαίνεται. Γρ. περαίνου- μεν.

ΠΑΡΟΡΑΜΑΤΑ.

Σελ. 171.	Στίχ. 2.	Ἀρχιμήδης. Γρ. Ἀρχιμήδης.
173.	31.	τῶν τὰς κτ. Γρ. αἱ αἱ κατώτεραι Τροχιλαῖαι περιβάλλονται. ὁμοίως καὶ Στίχ. 35. καὶ Σελ. 174. 15, καὶ 175. 11.
176.	31.	ἐν τῷ κτ. Γρ. ἐν τῇ Ψαμμίτιδι.
178.	29.	τῶ τριτάτῳ. Γρ. τέτῳ τῷ.
180.	14.	ΚΕ. Γρ. ΚΗ.
182.	11.	ἵνα ἐκ. Γρ. ἵνα δοθέντων.
αὐτ.	33.	εἶπε. Γρ. εἶφη.
194.	29.	καὶ περιβαλλέτω. Γρ. καὶ περιβαλλέτω ἢ Τροχιλαῖα.
αὐτ.	34.	τὸ κτ. Γρ. ὁ αὐτὴ περιβάλλεται.
197.	19.	ἐκ δὲ κτ. Γρ. τῇ δὲ δείξει ταύτη.
204.	8.	καὶ 207. 16. καὶ Γρ. λέγω δὴ ὅτι.
αὐτ.	16.	πρὸς τὸ. Γρ. πρὸς τῷ. ὁμοίως καὶ στίχ. 18, 20, 21, 23, 24, καὶ 25.
207.	20.	ἐπειδὴ. Γρ. ἐπειδὴ γὰρ.
212.	10.	δαπανώμενα. Γρ. δαπανώμενον.
227.	3.	εἶφμεν. Γρ. εἶπομεν.
259.	27.	εἰάν ἔν θῶμεν. Γρ. εἰάν ἔν τὸ Β εἴδειμίαν ἔχη.
261.	16.	ἢ καὶ κτ. Γρ. ὡς ὁ Νελέτας ἐν τῷ 1. Τόμ. τῆς Φυσικ. αὐτῆ ἐπιξεῖσαι.
277.	(α)	αἱ. Γρ. αἱ.
301.		χαλκαίνθη. Γρ. χαλκαίνθη.
αὐτ.		χρυσομήλε. Γρ. μηδικῆ Μίλε.
302.		κλώνες. Γρ. κλών.
αὐτ.		κύσιδι. Γρ. κύσει.
304.		χαλκαίνθης. Γρ. χαλκαίνθη.
307.		15. Ἀρχιμήδης. Γρ. Ἀρχιμήδης.
320.		13. ταῖς. Γρ. ταῖς.

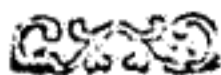

σλ. 1.



σλ. 3.

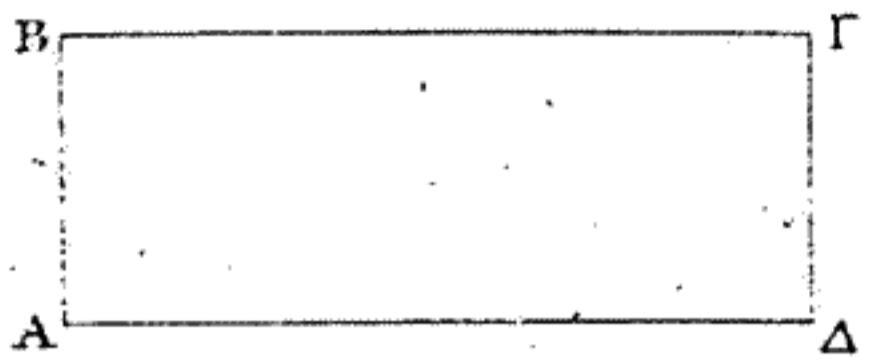

σλ. 4.

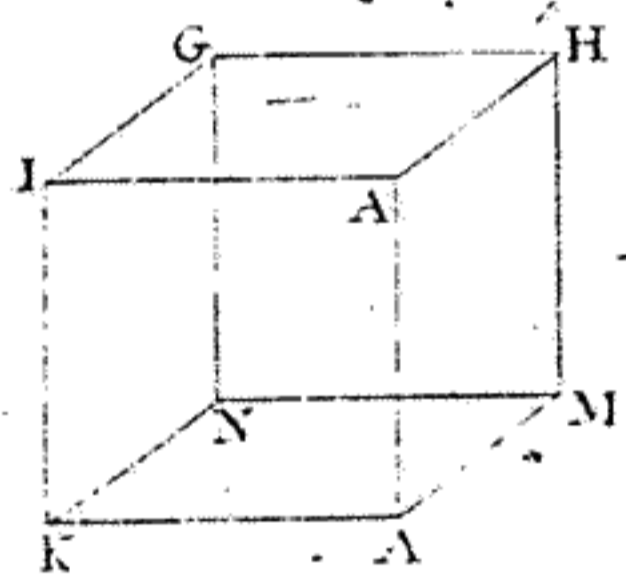

σλ. 5.



σλ. 6.

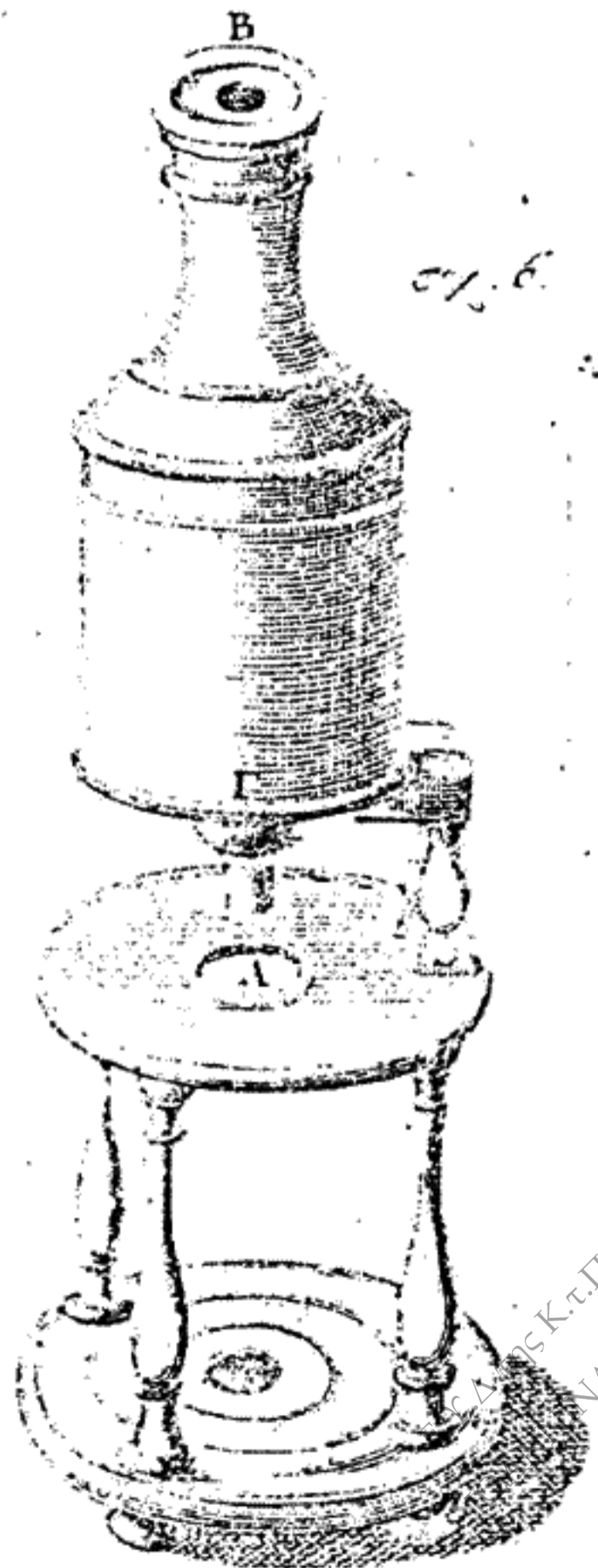

ΠΑΝΕΠΙΣΤΗΜΙΟ ΙΩΑΝΝΙΝΩΝ
ΤΟΜΕΑΣ ΦΙΛΟΣΟΦΙΑΣ
ΕΡΓΑΣΤΗΡΙΟ ΕΡΕΥΝΩΝ ΝΕΟΕΛΛΗΝΙΚΗΣ ΦΙΛΟΣΟΦΙΑΣ
ΔΙΕΥΘΥΝΤΗΣ: ΕΠ. ΚΑΘΗΓΗΤΗΣ ΚΩΝΣΤΑΝΤΙΝΟΣ Θ. ΠΕΤΣΙΟΣ

ΕΛΛΗΝΙΚΗ ΔΗΜΟΚΡΑΤΙΑ
ΥΠΟΥΡΓΕΙΟ ΠΑΙΔΕΙΑΣ, ΕΡΕΥΝΑΣ ΚΑΙ ΘΡΗΣΚΕΥΜΑΤΩΝ
ΙΝΣΤΙΤΟΥΤΟ ΤΕΧΝΟΛΟΓΙΑΣ ΥΠΟΛΟΓΙΣΤΩΝ ΚΑΙ ΕΚΔΟΣΕΩΝ ΔΙΔΑΚΤΙΚΩΝ ΒΙΒΛΙΩΝ
Κ. Δ. Μ. Π. Κ. Τ. Π.
Α. Α. Β. Α. 2006

σλ. 1.

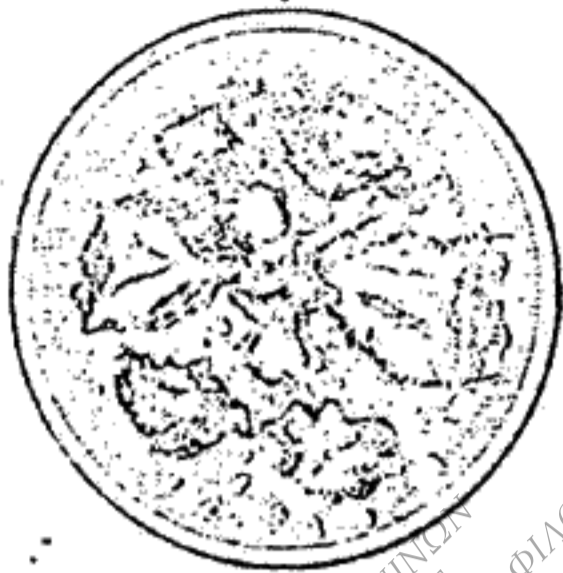

σλ. 2.

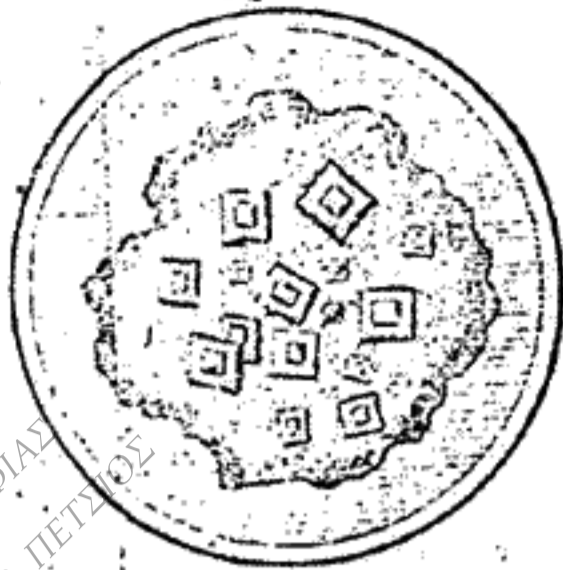

σλ. 3.



σλ. 4.

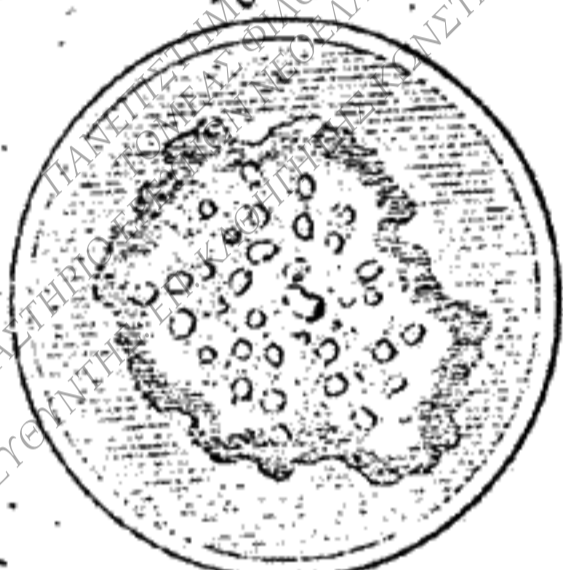

σλ. 5.



σλ. 6.



σλ. 7.

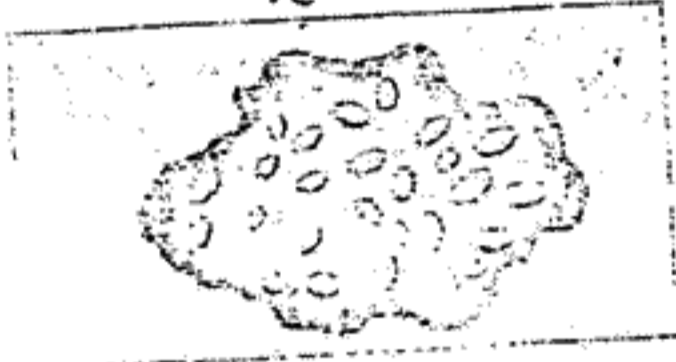

σλ. 9.

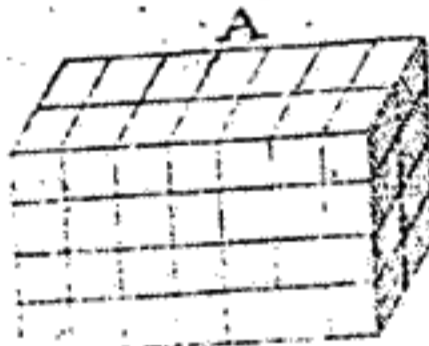

σλ. 10.



σλ. 8.

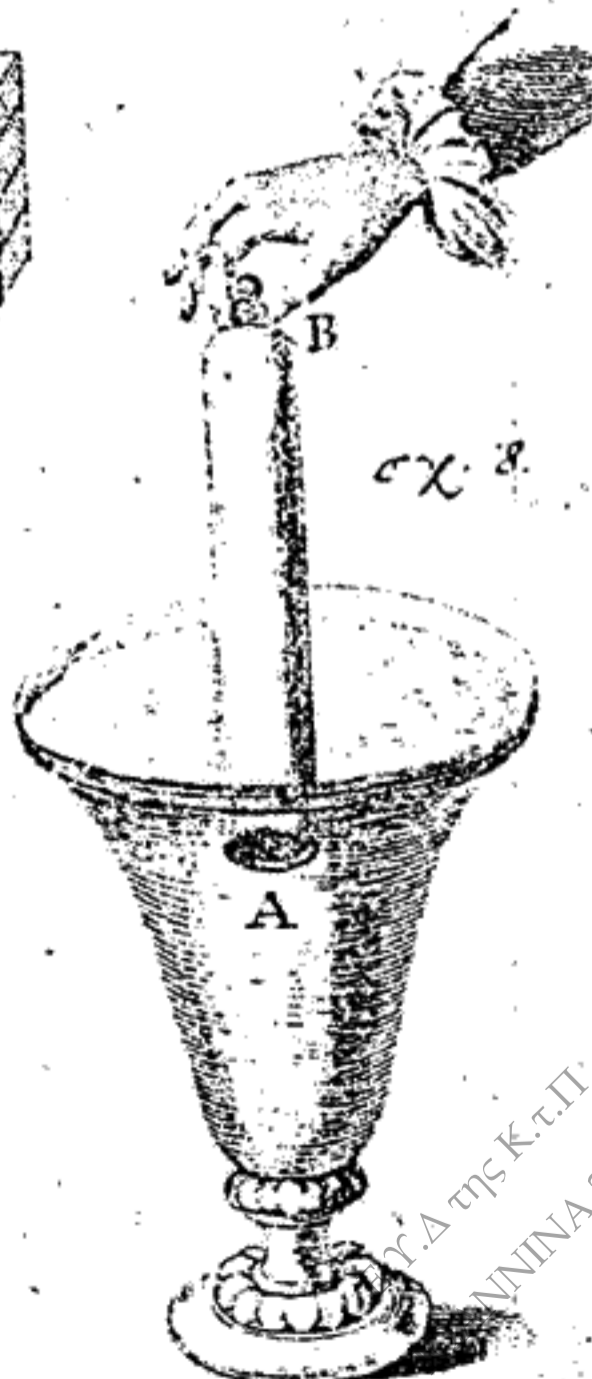

σλ. 11.

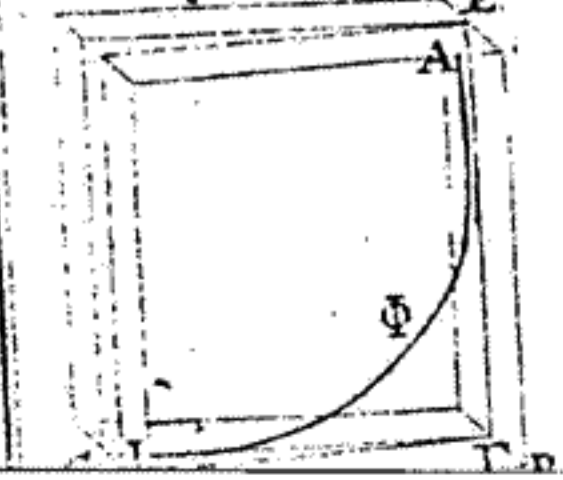

σλ. 12.

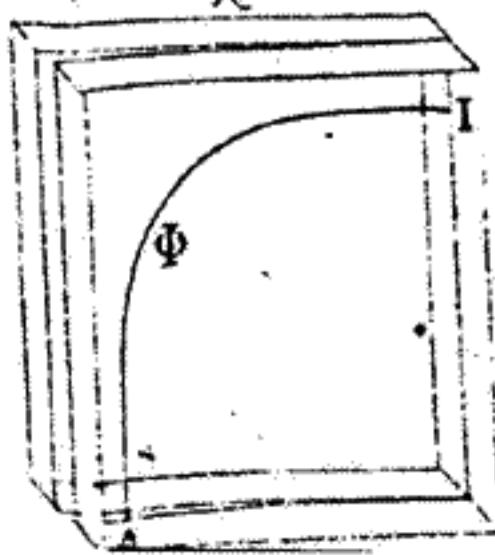

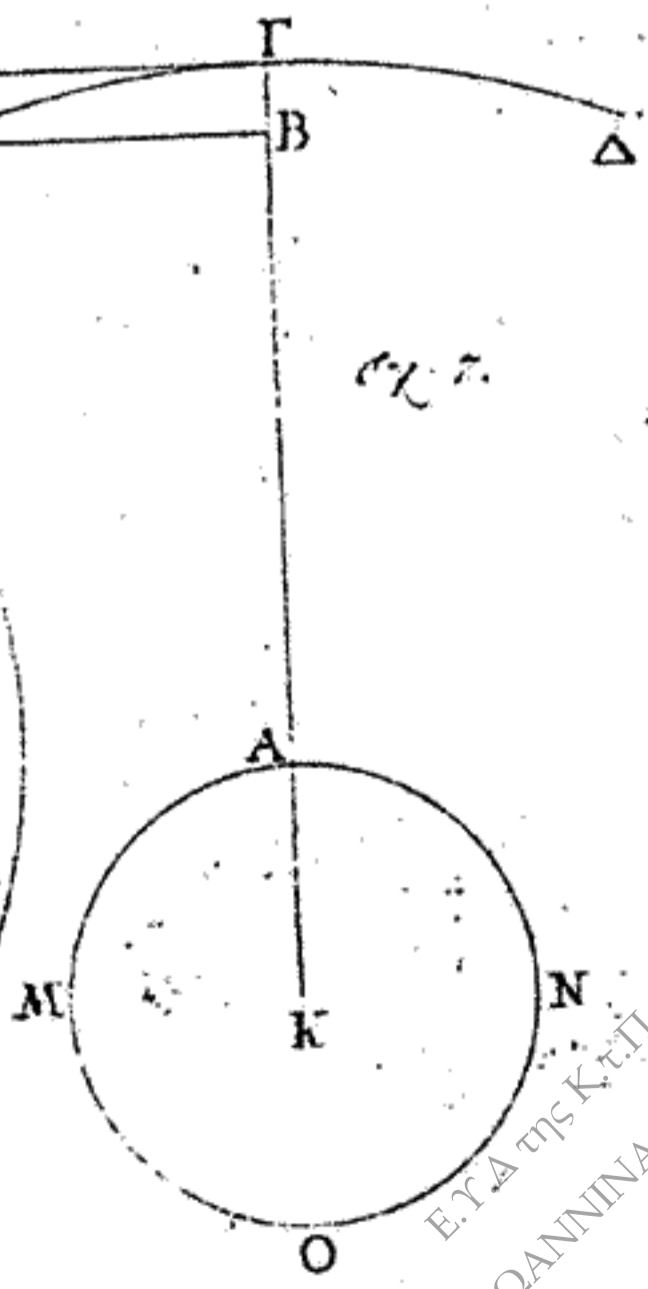
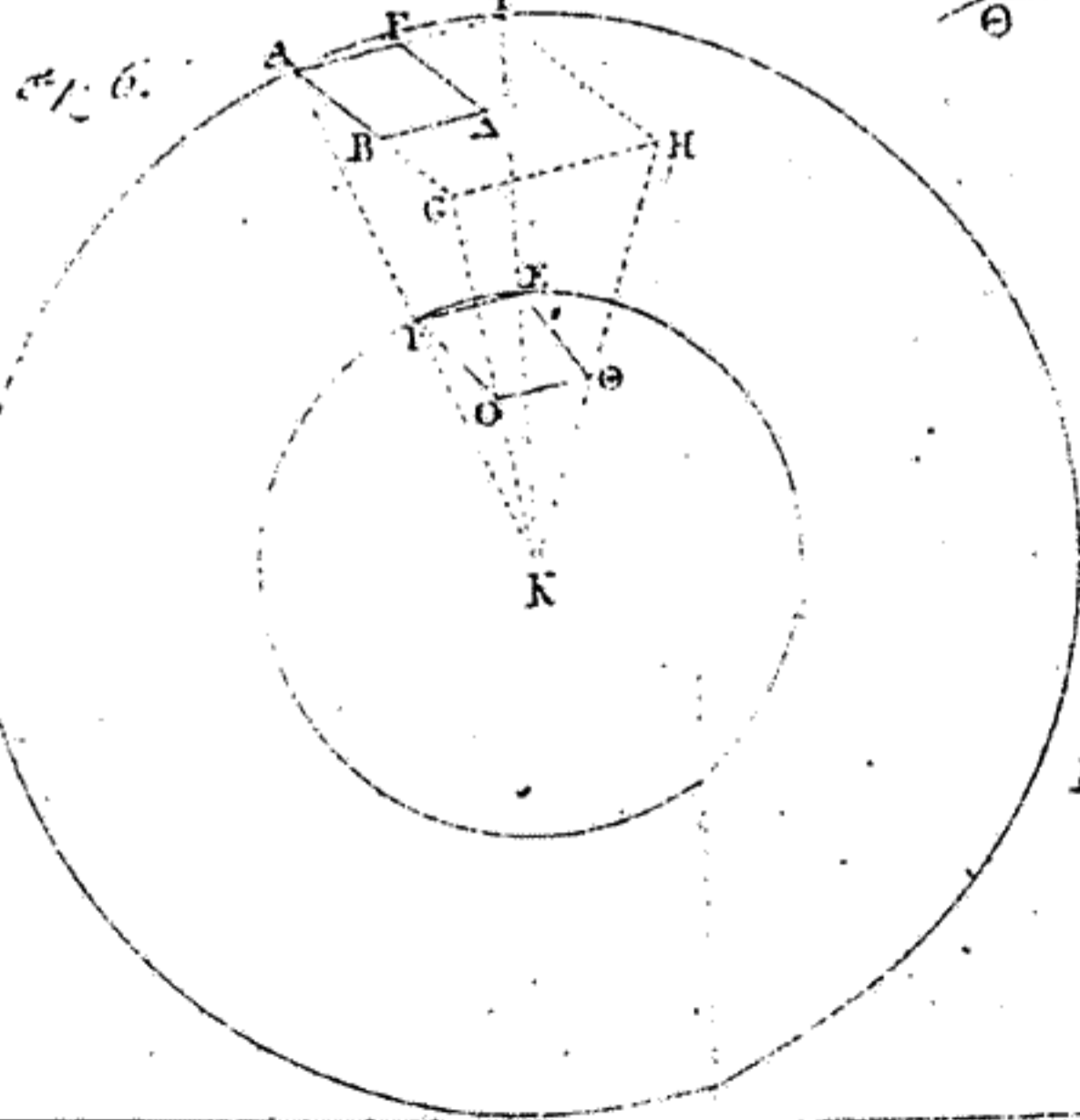
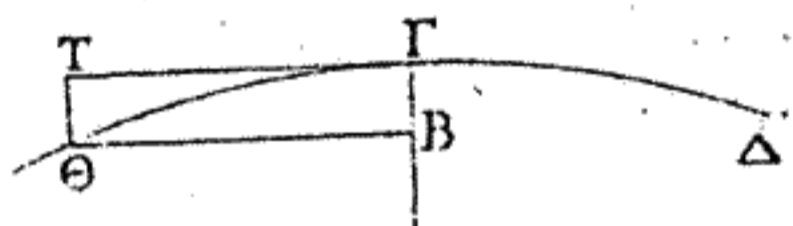
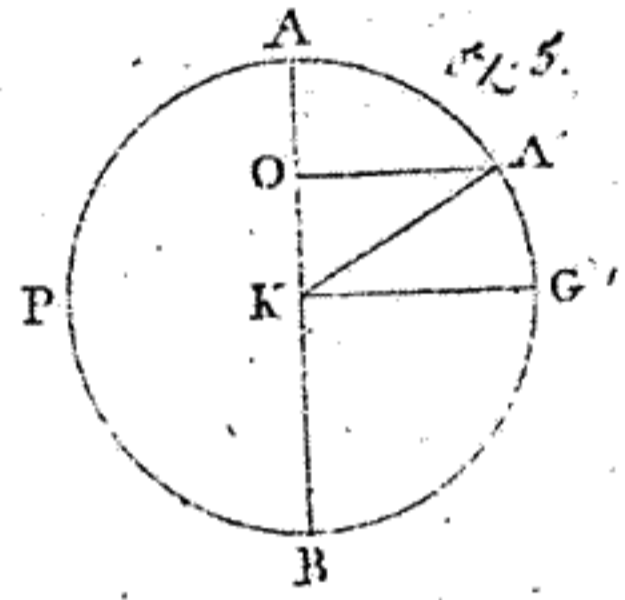
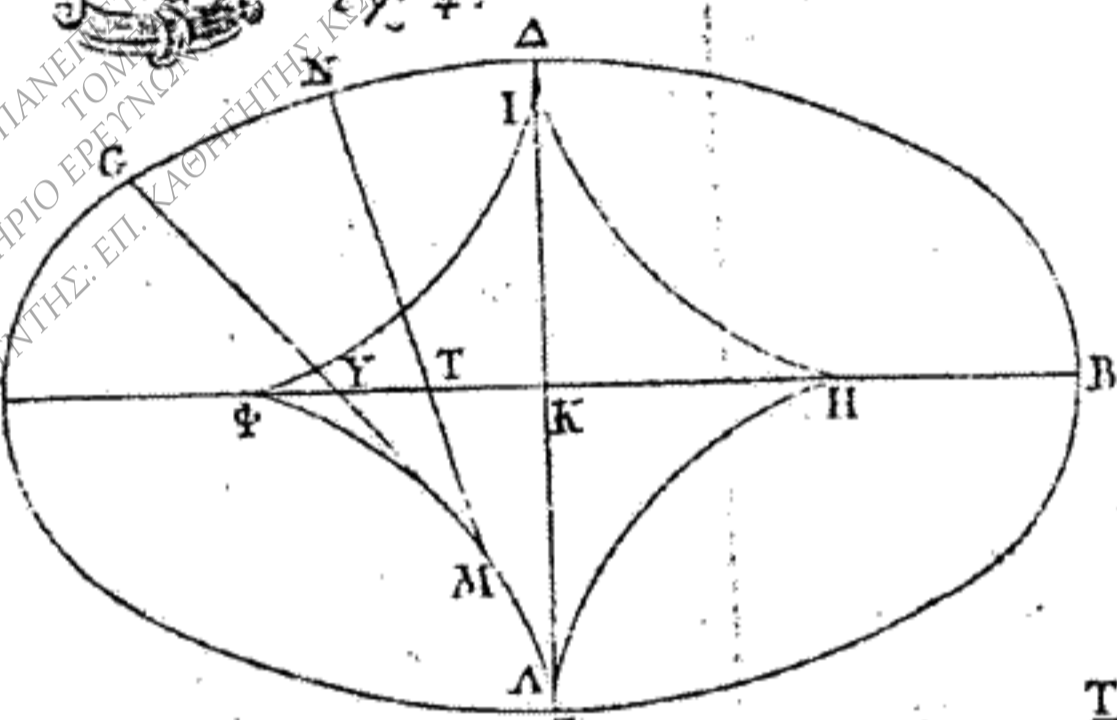
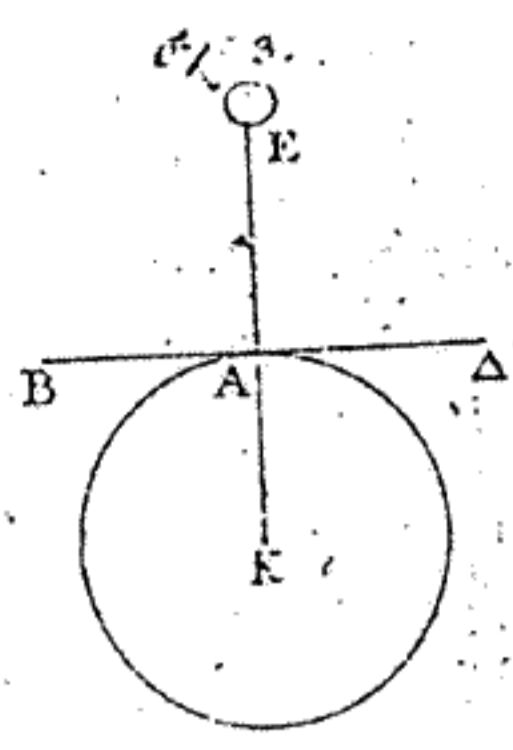
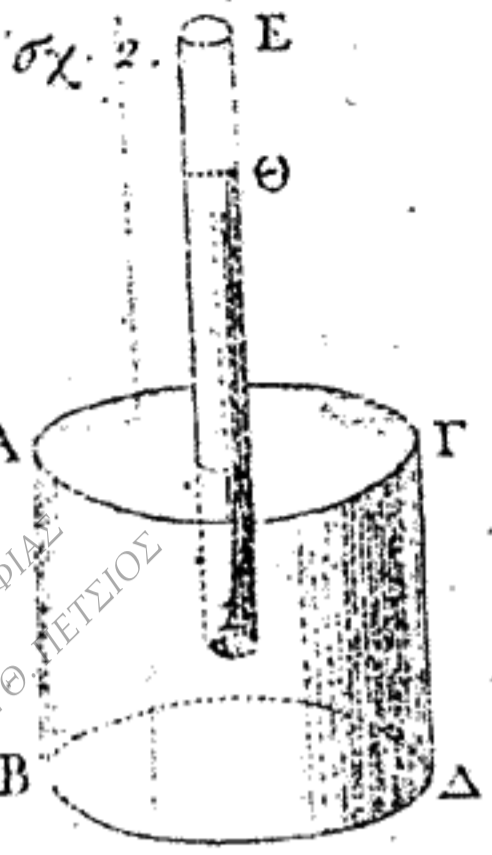
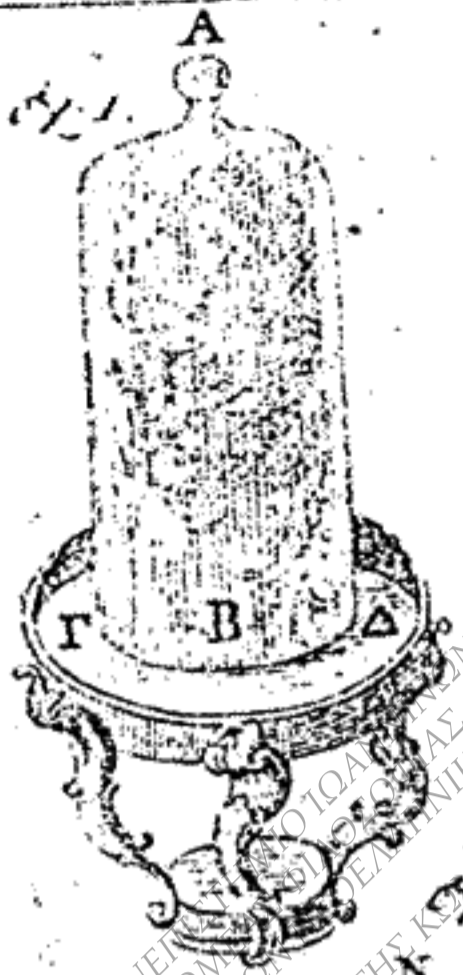

ΠΑΝΕΠΙΣΤΗΜΙΟΝ ΙΩΑΝΝΙΝΩΝ
 ΕΡΓΑΣΤΗΡΙΟ ΕΡΕΥΝΩΝ ΦΙΛΟΣΟΦΙΑΣ
 ΑΡΧΙΜΕΔΟΥΣ ΕΠ. ΚΑΘΗΓΗΤΗΣ ΚΩΝΣΤΑΝΤΙΝΟΣ Θ. ΠΙΤΣΙΟΣ

Ε.Υ.Δ. της Κ.τ.Π.
 ΙΩΑΝΝΙΝΑ 2006

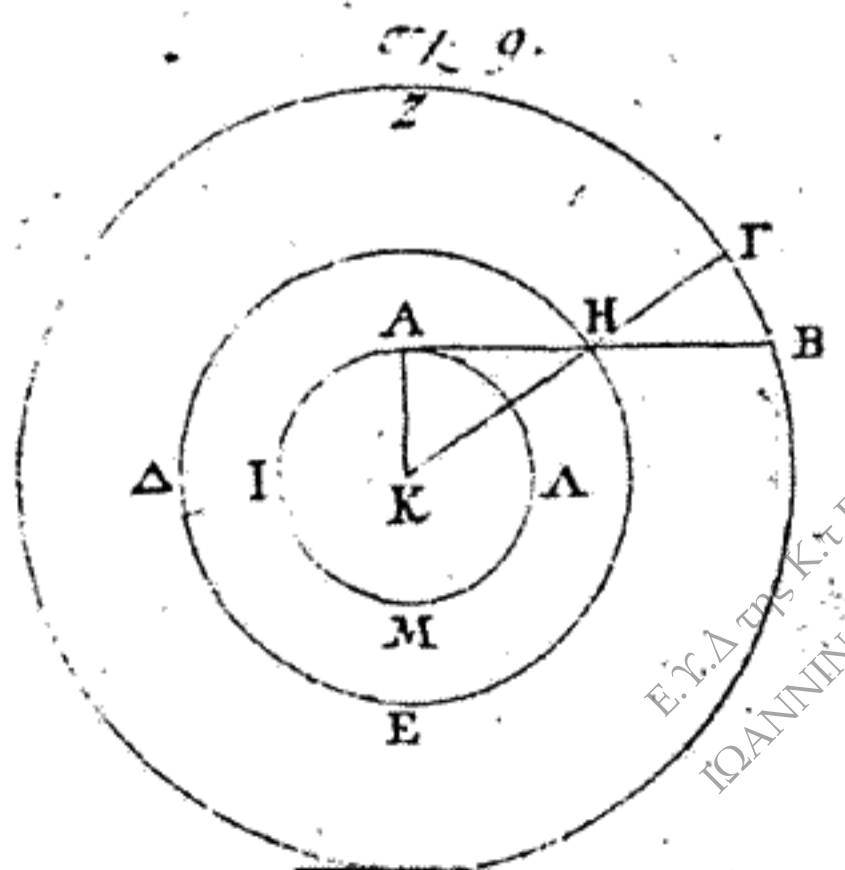
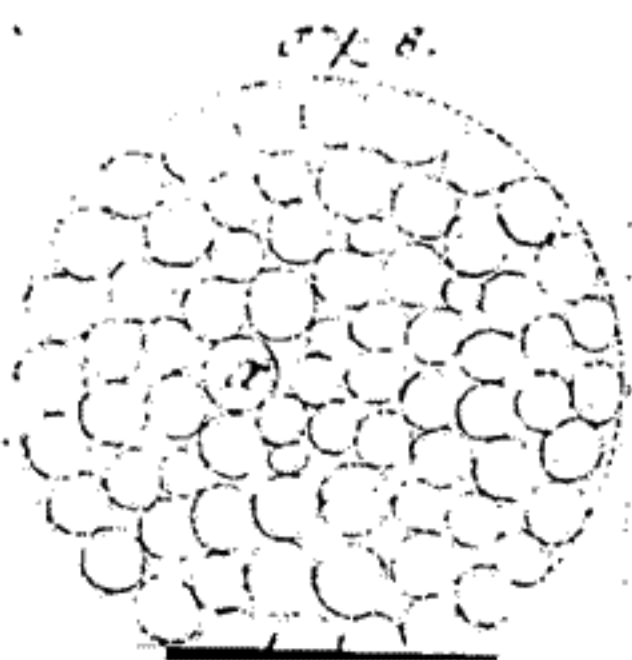
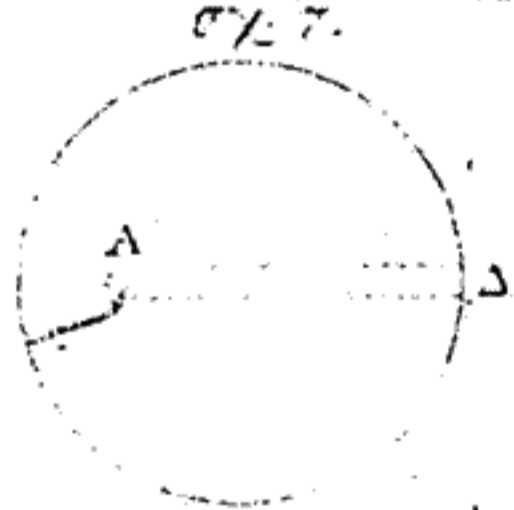
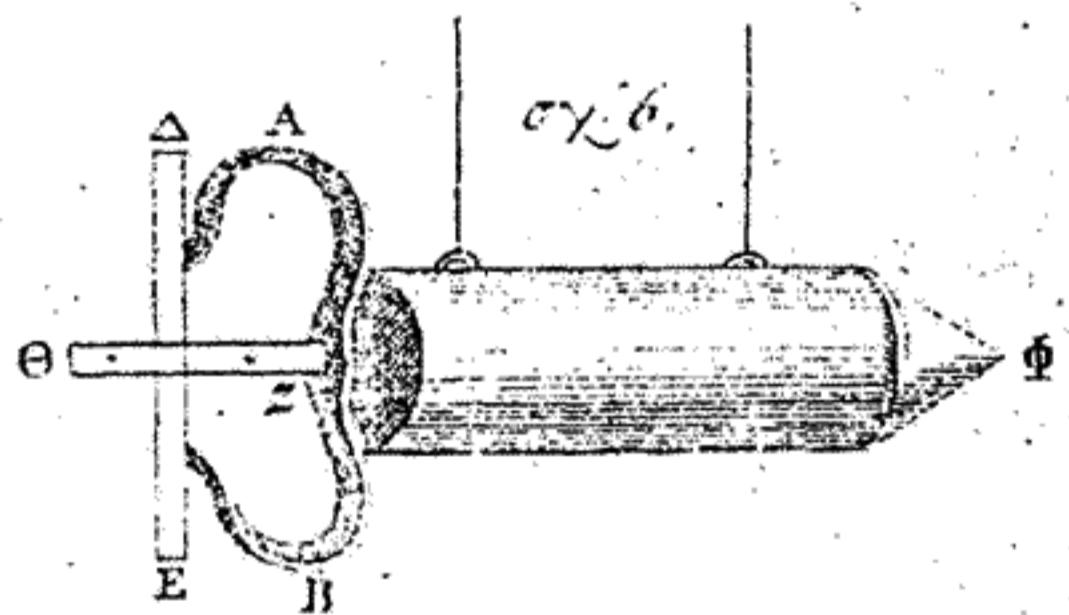
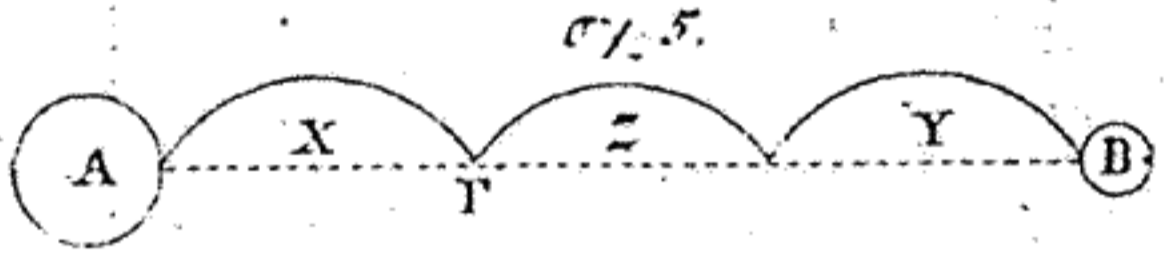
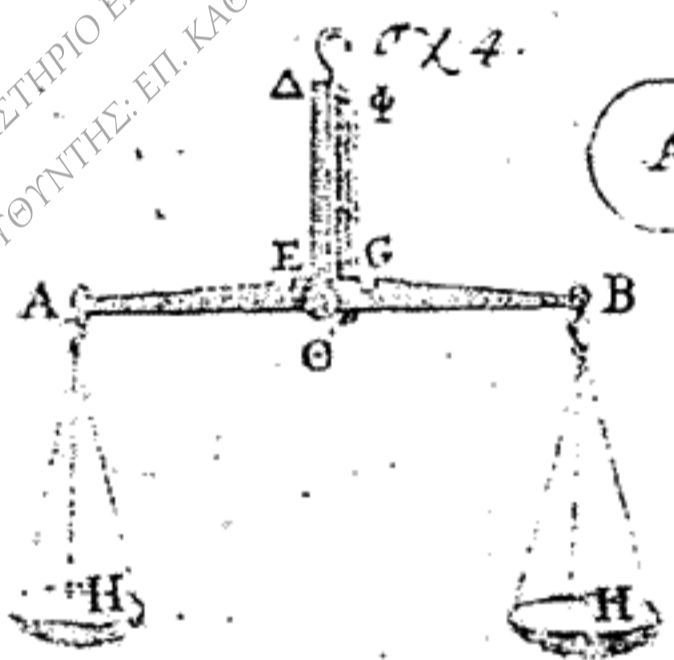
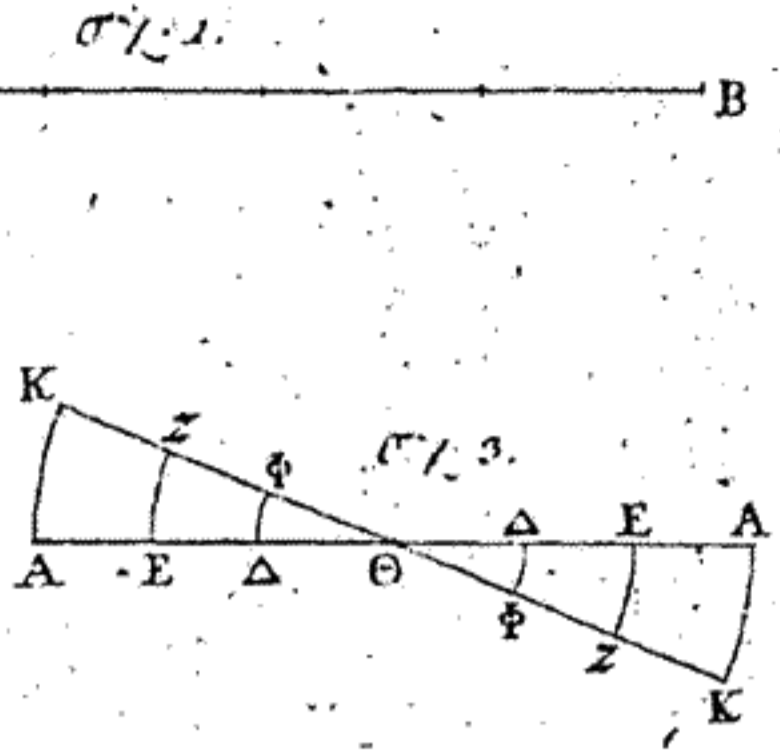
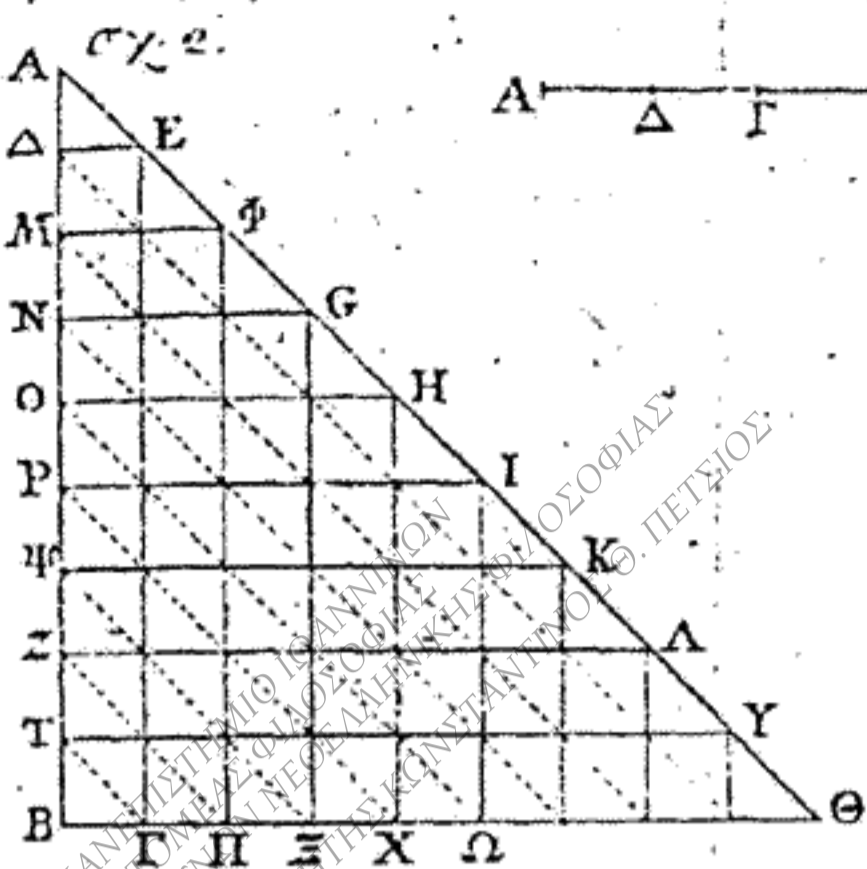

ΠΑΝΕΠΙΣΤΗΜΙΟ ΙΩΑΝΝΙΝΩΝ
 ΕΡΓΑΣΤΗΡΙΟ ΕΡΕΥΝΑΣ ΚΑΙ ΝΕΟΛΑΜΝΙΚΗΣ ΦΥΣΙΟΣΟΦΙΑΣ
 ΔΙΕΥΘΥΝΤΗΣ: ΕΠ. ΚΑΘΗΓΗΤΗΣ ΚΩΝΣΤΑΝΤΙΝΟΣ ΠΕΤΣΙΟΣ

Ε.Υ.Δ. ΕΡΓ. Κ.Τ.Π
 ΙΩΑΝΝΙΝΑ 2006

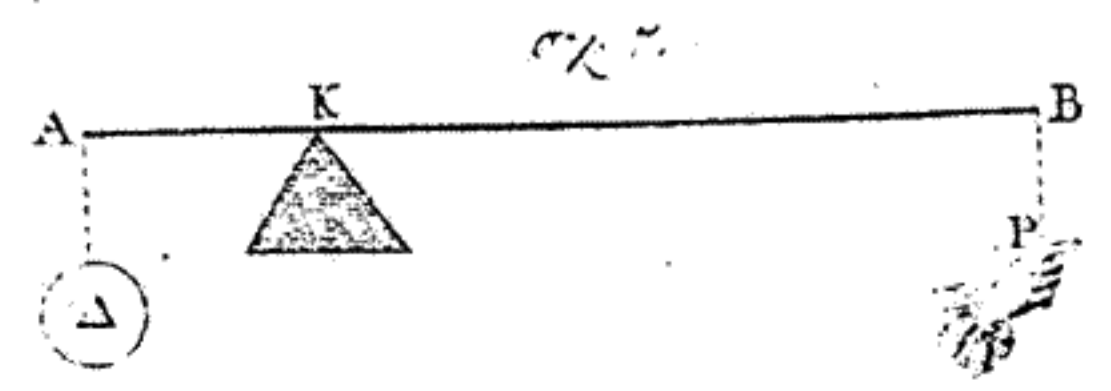
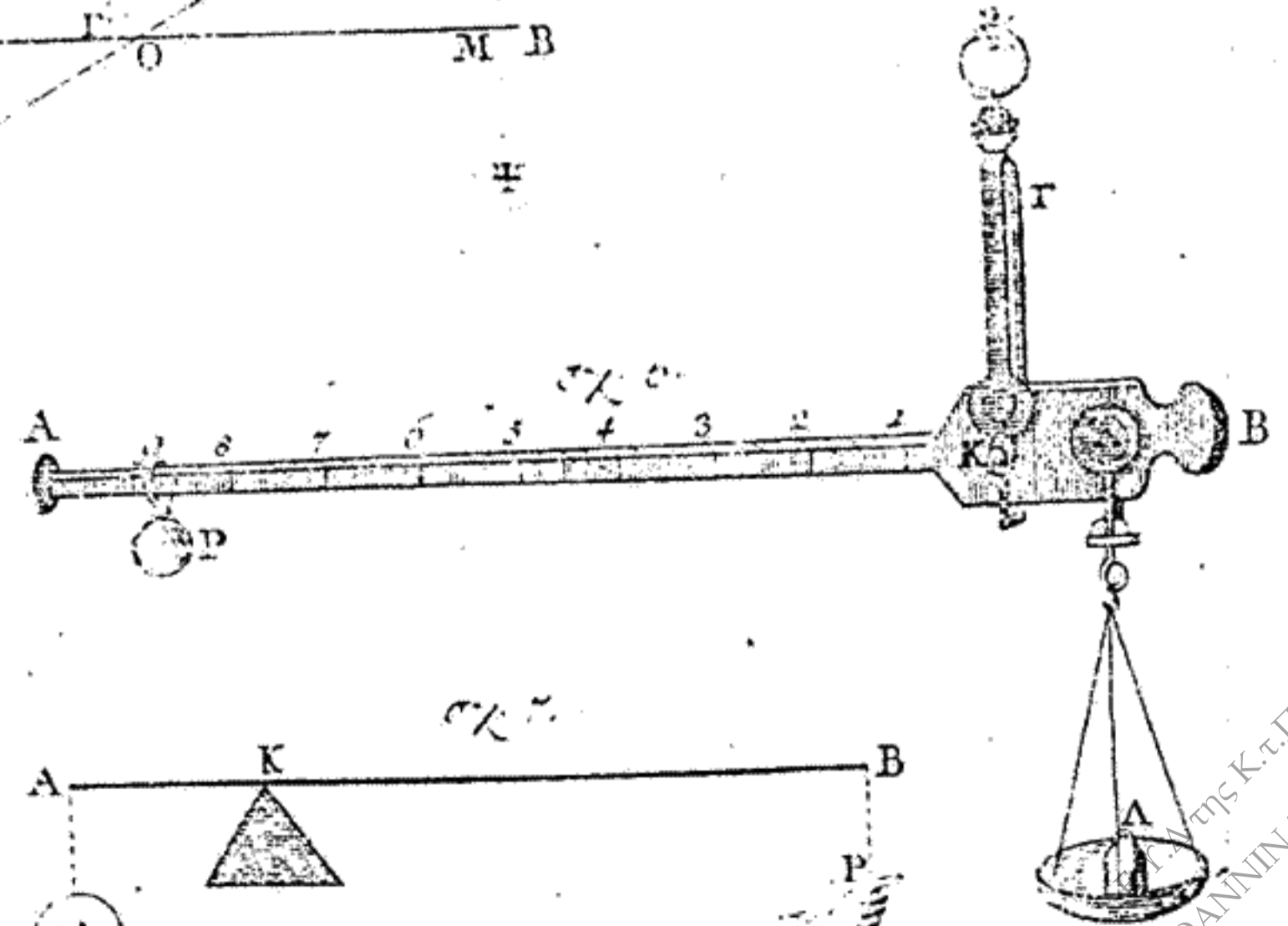
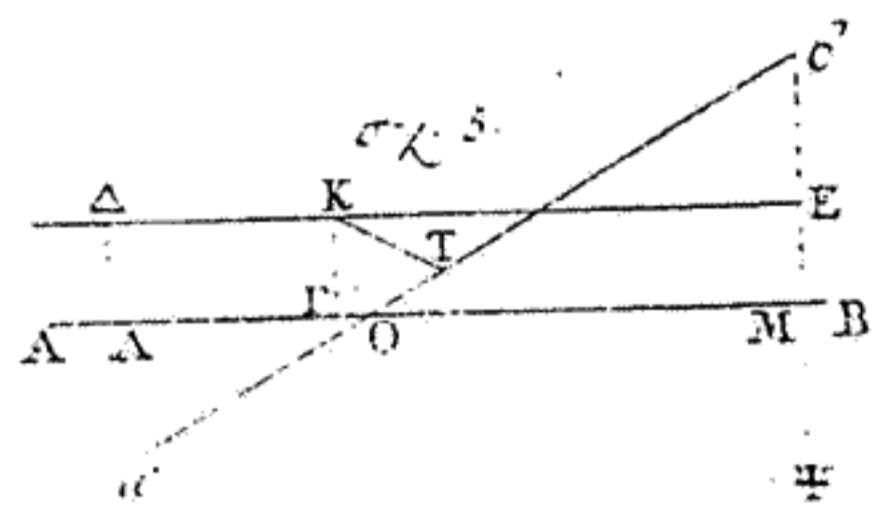
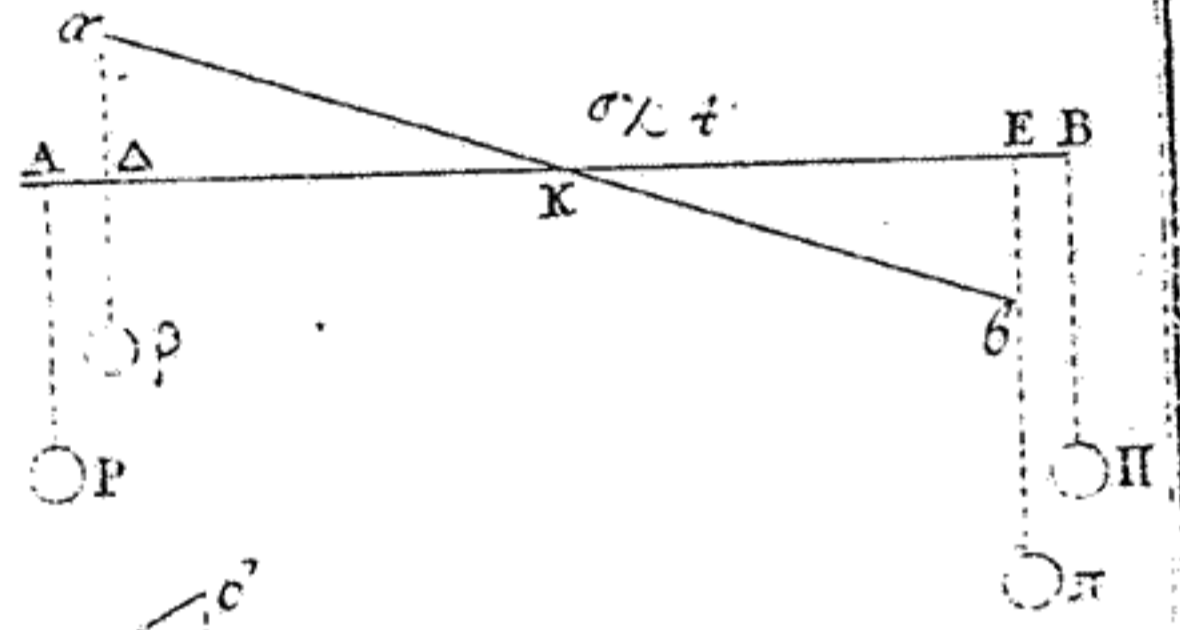
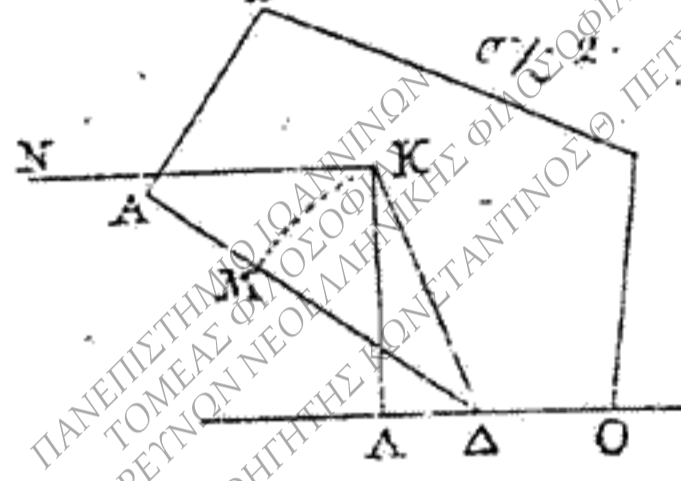
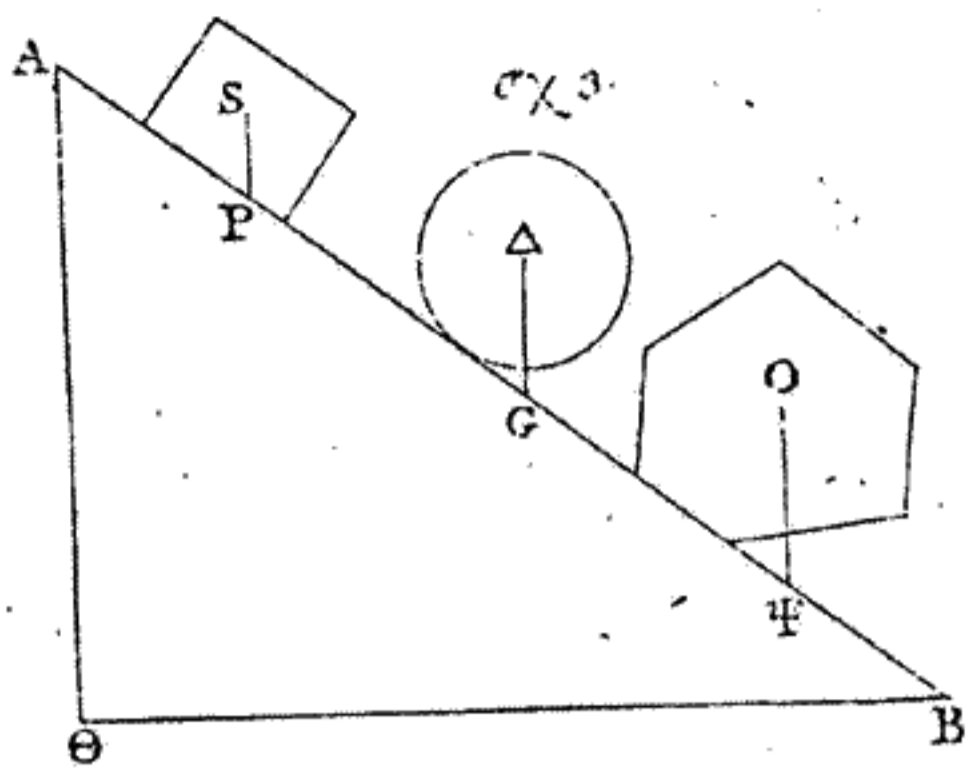
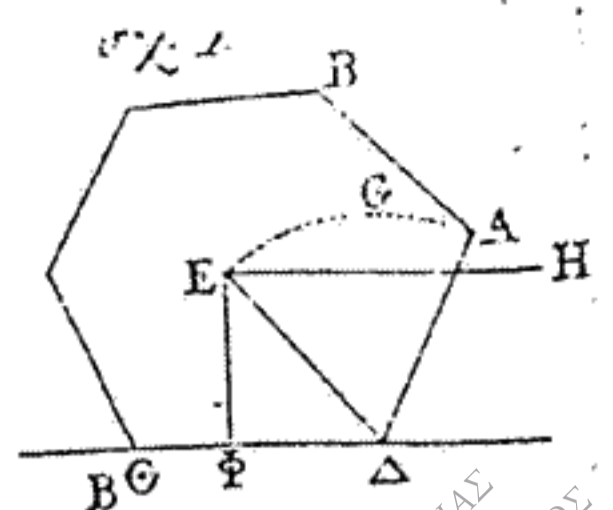

ΠΑΝΕΠΙΣΤΗΜΙΟ ΙΩΑΝΝΙΝΩΝ
 ΤΟΜΕΑΣ ΦΙΛΟΣΟΦΙΑΣ
 ΕΡΓΑΣΤΗΡΙΟ ΕΡΕΥΝΩΝ ΝΕΟΛΑΜΗΡΚΗΣ ΦΙΛΟΣΟΦΙΑΣ
 ΜΕΛΟΥΝΤΗΣ: ΕΠ. ΚΑΘΗΓΗΤΗΣ ΚΩΝΣΤΑΝΤΙΝΟΣ Θ. ΠΕΤΣΙΟΣ

ΙΩΑΝΝΙΝΑ 2006

σχ. 1.

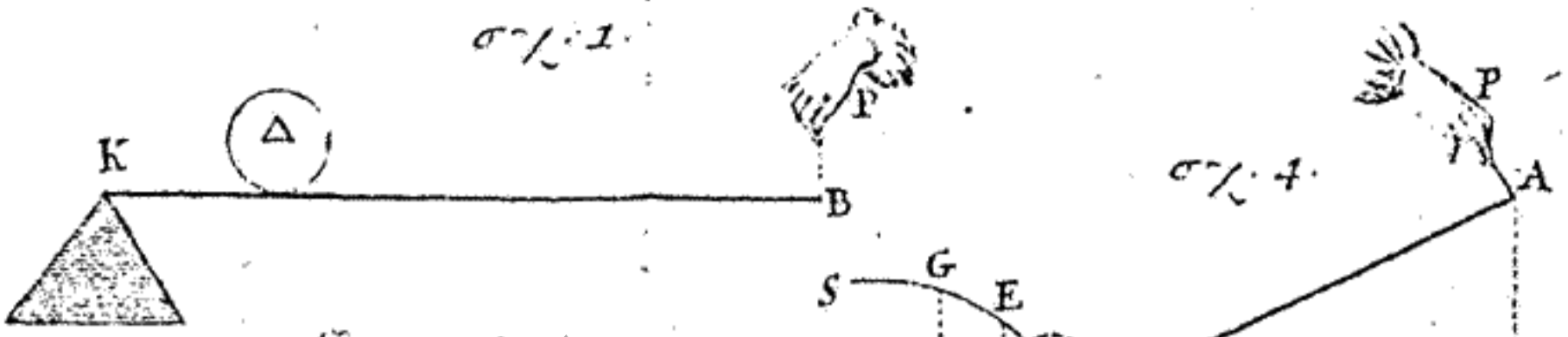

σχ. 4.

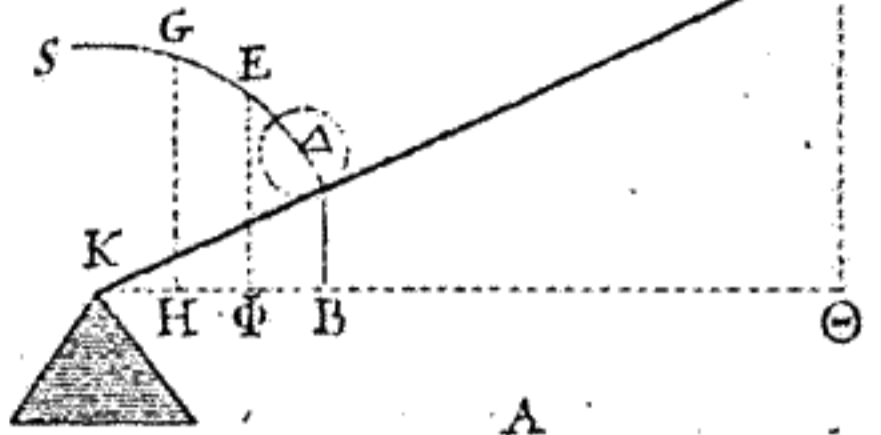

σχ. 2.

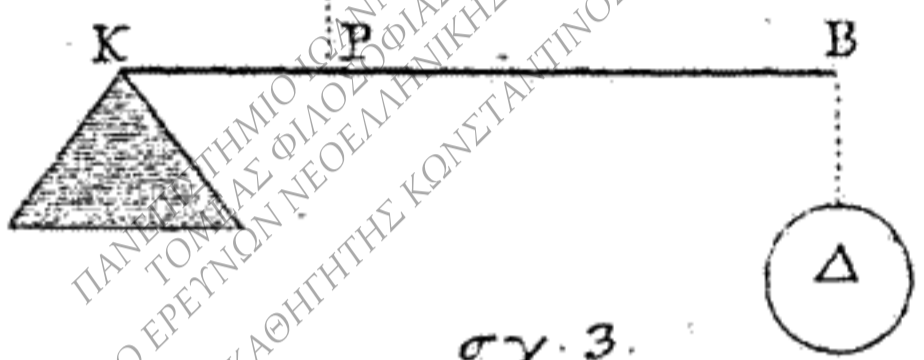

σχ. 3.

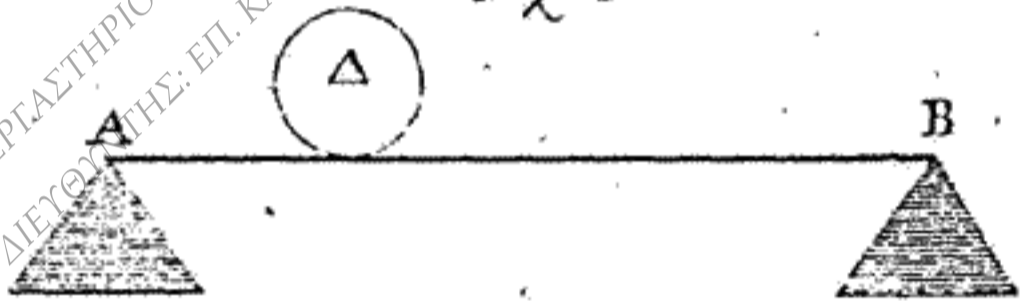

σχ. 5.

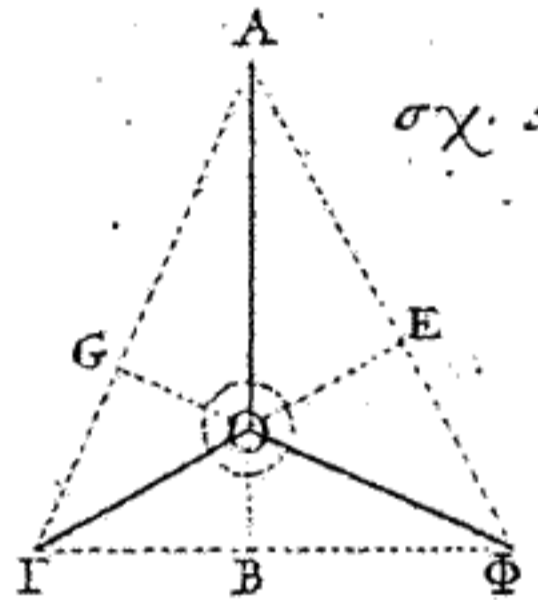

σχ. 6.

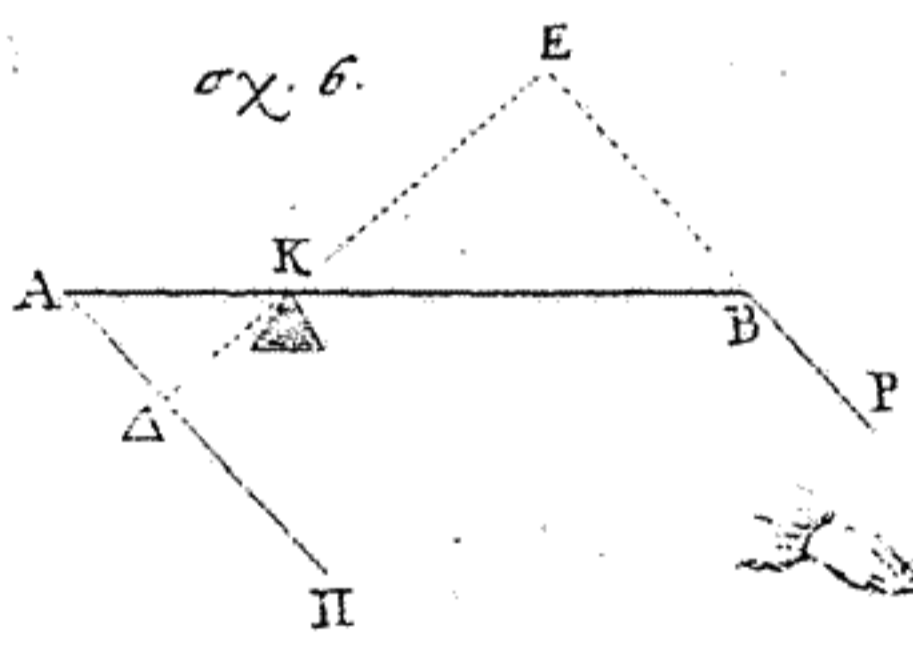

σχ. 7.

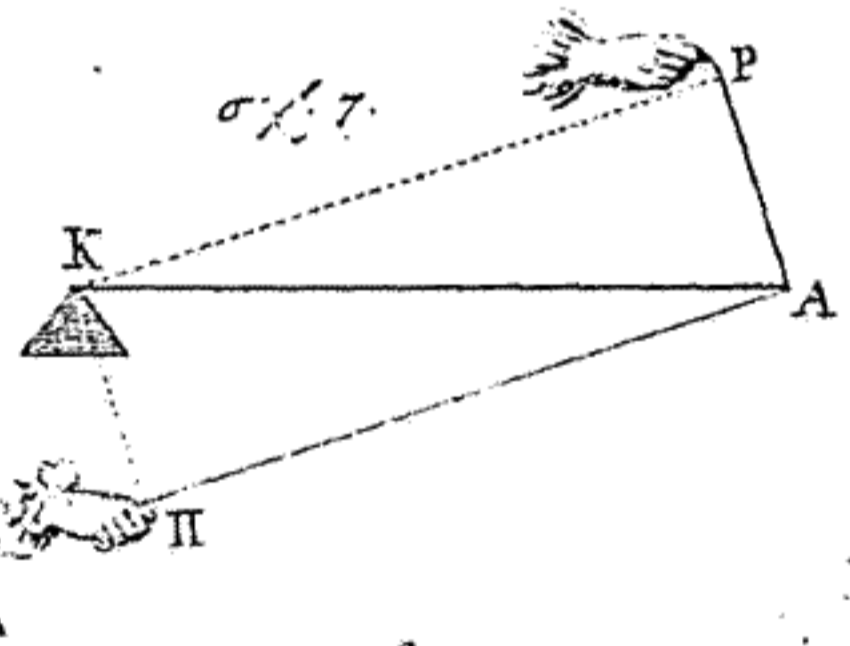

σχ. 8.

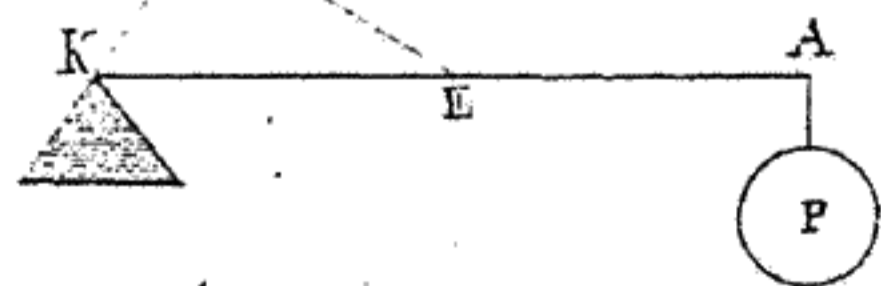

σχ. 9.

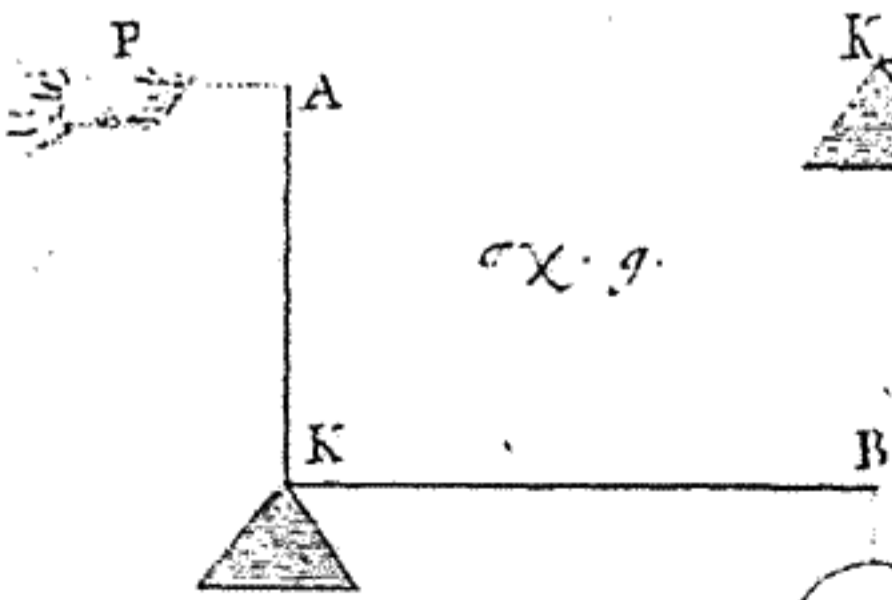

σχ. 10.

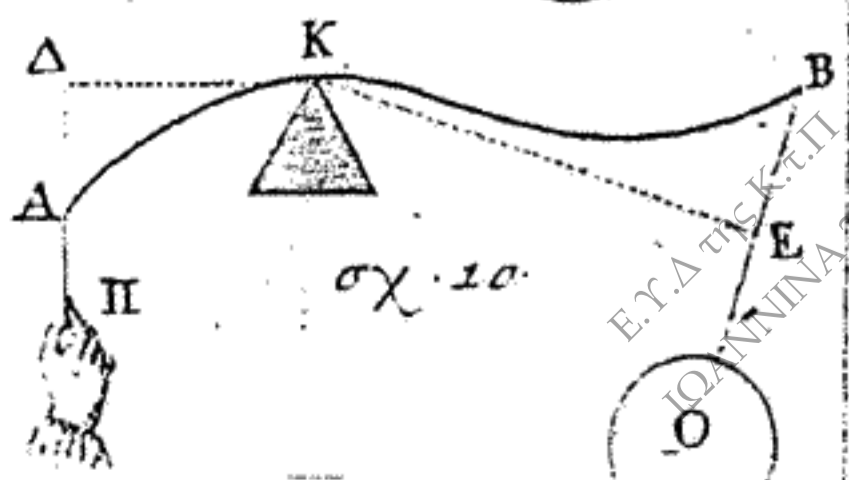

ΠΑΝΕΠΙΣΤΗΜΙΟ ΙΩΑΝΝΙΝΩΝ
 ΤΟΜΕΑΣ ΦΙΛΟΣΟΦΙΑΣ
 ΕΡΓΑΣΤΗΡΙΟ ΕΡΕΥΝΩΝ ΝΕΟΕΛΛΗΝΙΚΗΣ ΦΙΛΟΣΟΦΙΑΣ
 ΔΙΕΥΘΥΝΤΗΣ: ΕΠ. ΚΑΘΗΓΗΤΗΣ ΚΩΝΣΤΑΝΤΙΝΟΣ Θ. ΠΕΤΣΙΟΣ

Ε.Υ.Δ. ΤΗΣ Κ.Τ.Π.
 ΙΩΑΝΝΙΝΑ 2006

σχ. 1.

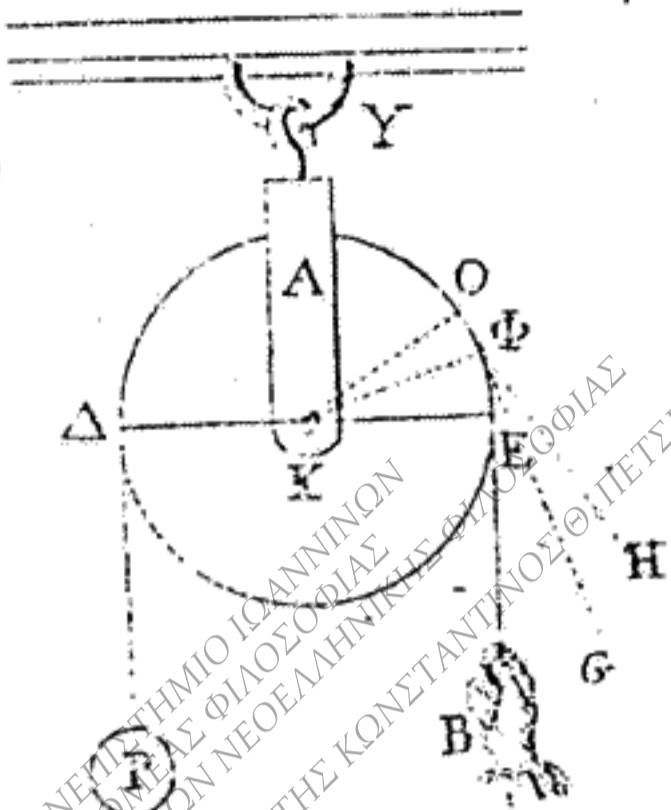

σχ. 2.

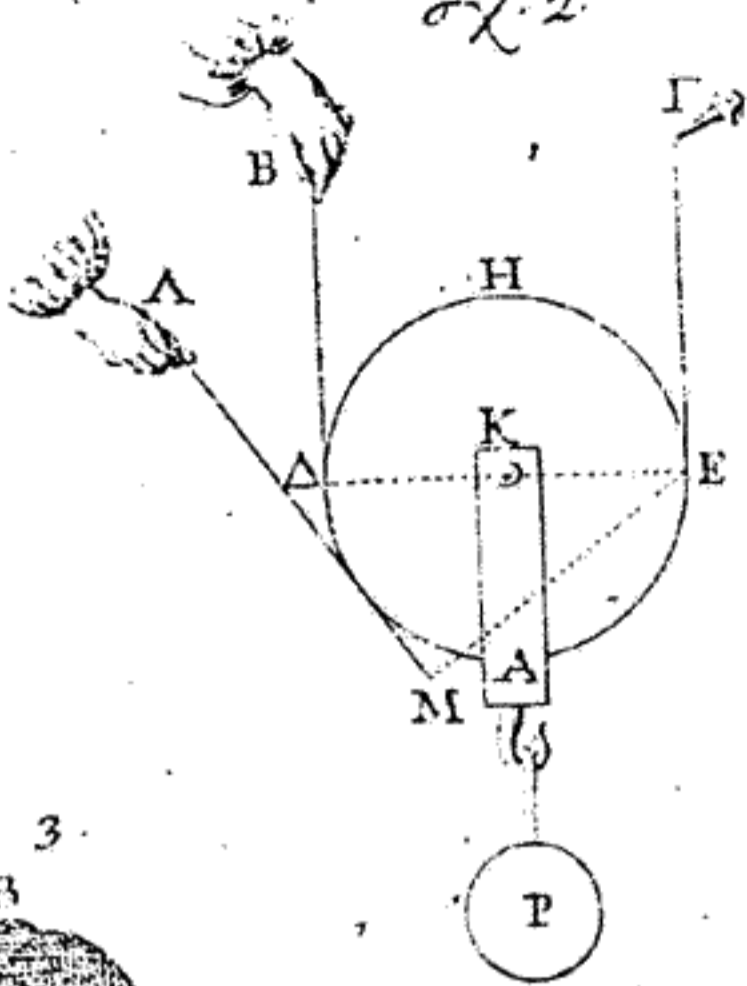

σχ. 3.

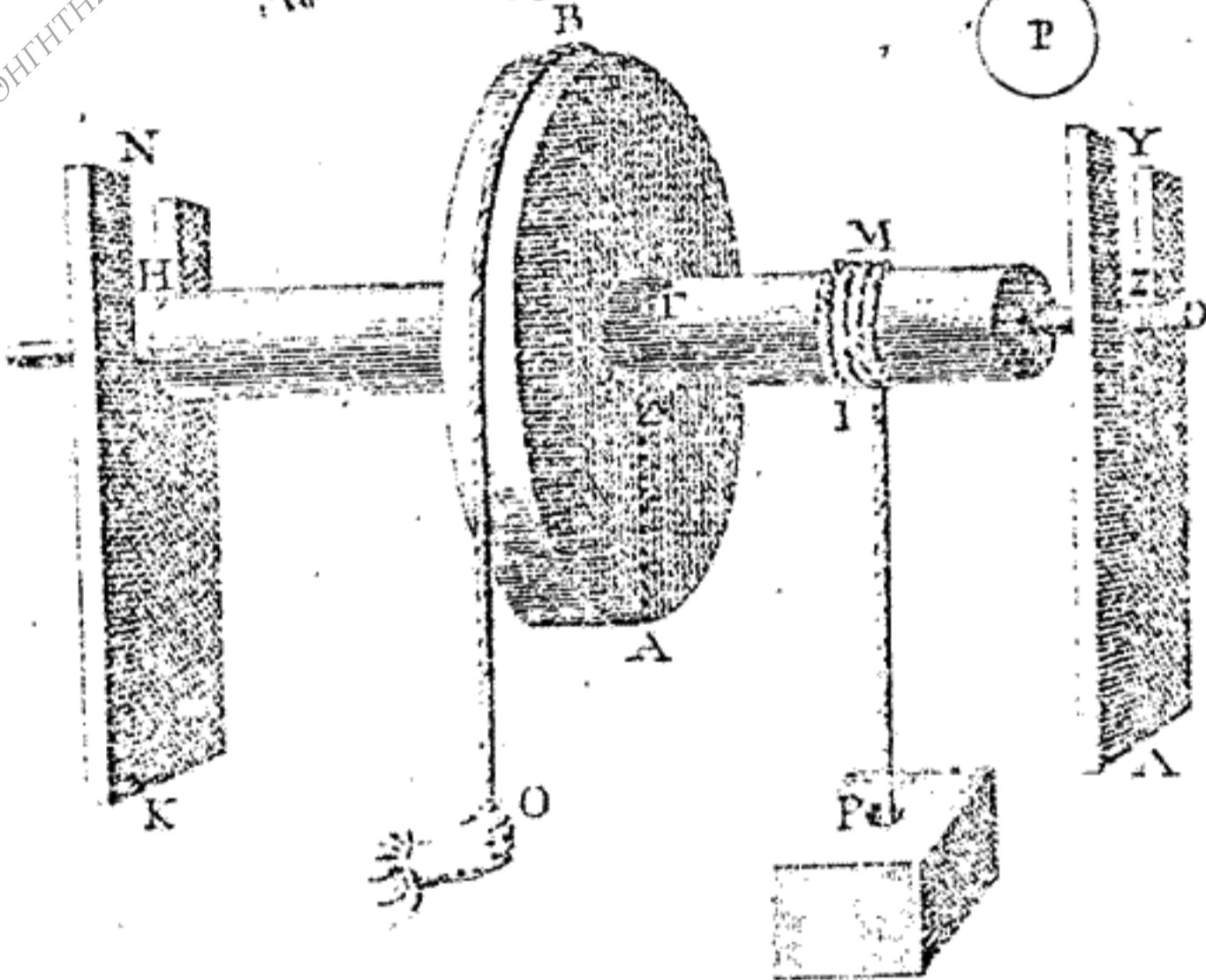

σχ. 4.

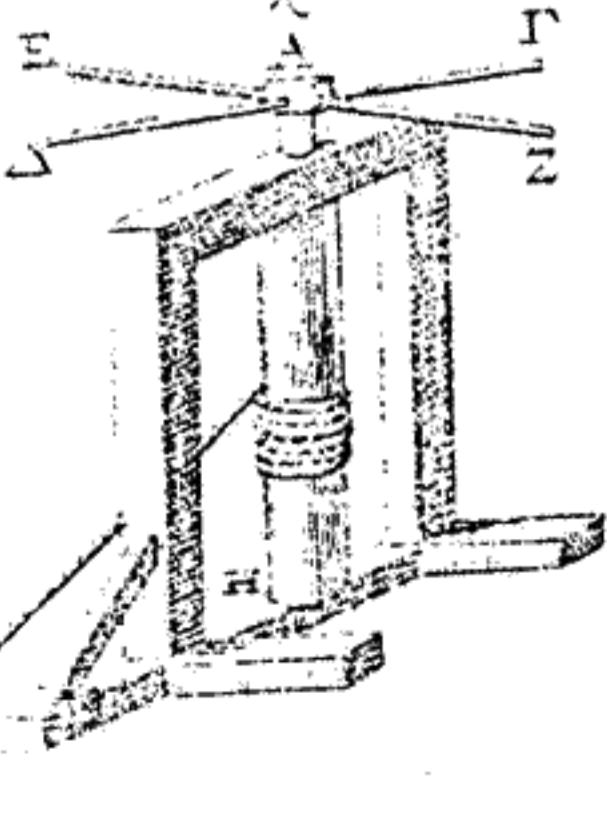

σχ. 5.

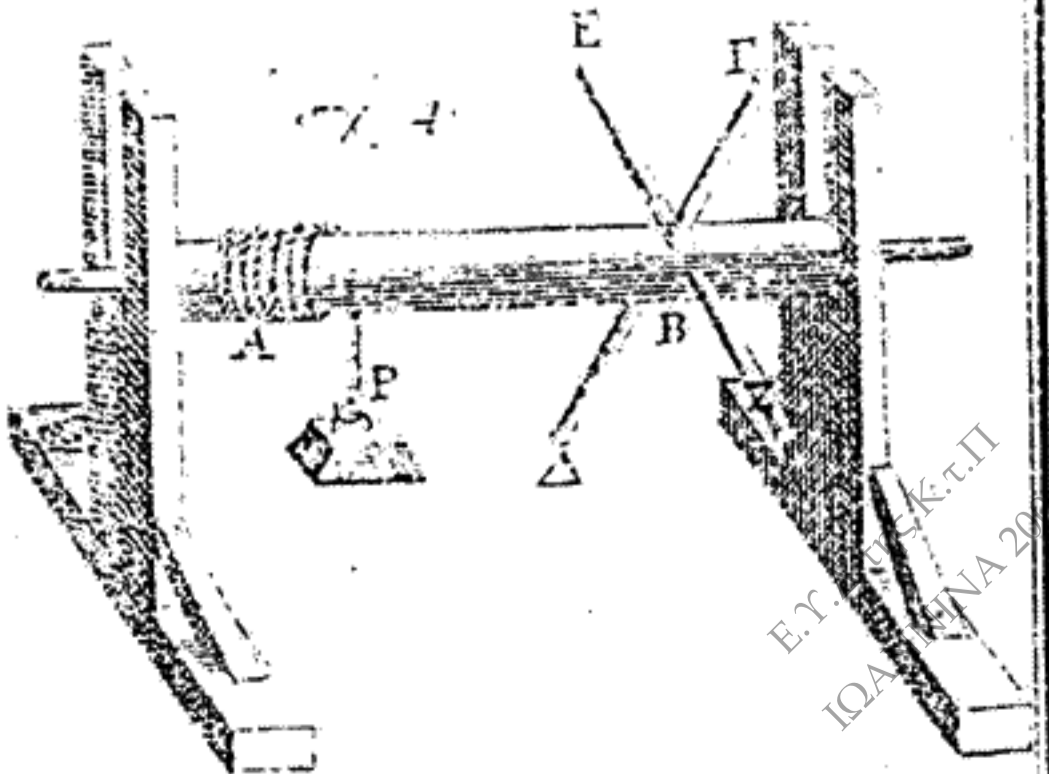

ΠΑΝΕΠΙΣΤΗΜΙΟ ΙΚΑΝΝΙΝΩΝ
 ΤΟΜΕΑΣ ΦΙΛΟΣΟΦΙΑΣ
 ΔΙΕΥΘΥΝΤΗΣ: ΕΠ. ΚΑΘΗΓΗΤΗΣ ΚΩΝΣΤΑΝΤΙΝΟΣ ΦΙΛΟΣΟΦΙΑΣ
 ΔΙΕΥΘΥΝΤΗΣ: ΕΠ. ΚΑΘΗΓΗΤΗΣ ΚΩΝΣΤΑΝΤΙΝΟΣ ΦΙΛΟΣΟΦΙΑΣ

Ε.Υ. ΣΤ.Κ.Τ.Π
 ΙΩΑΝΝΙΝΑ 2006

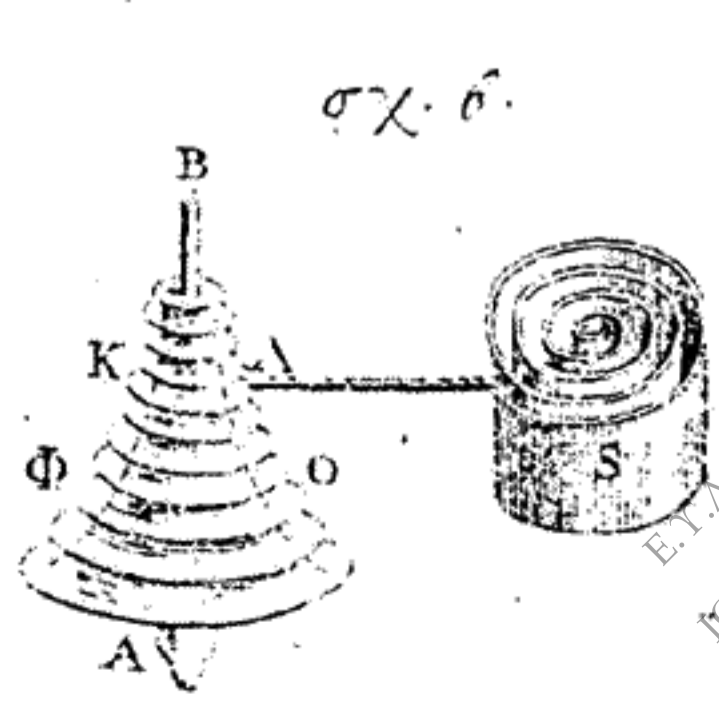
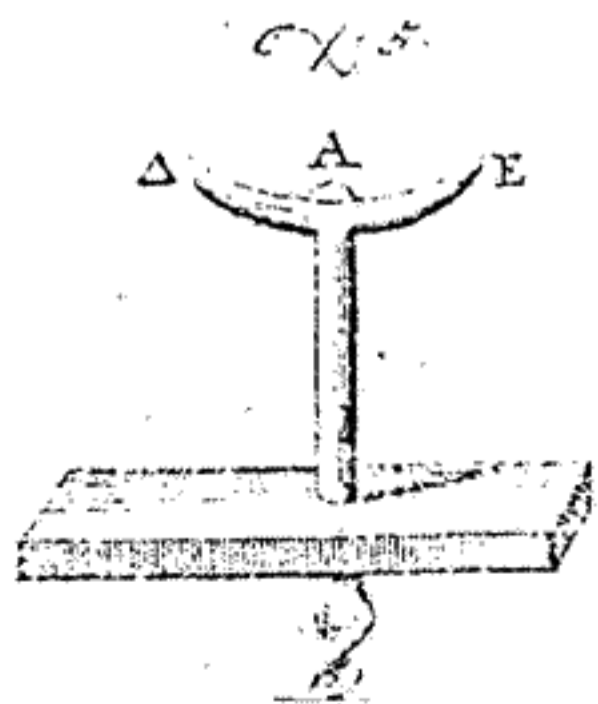
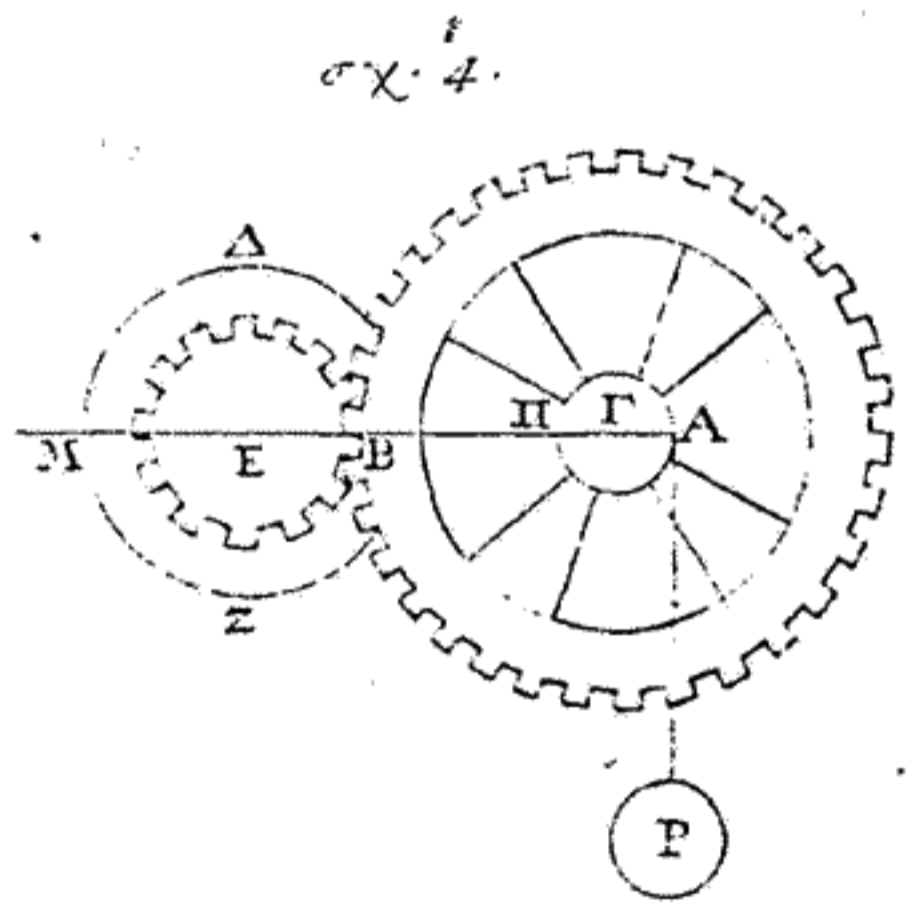
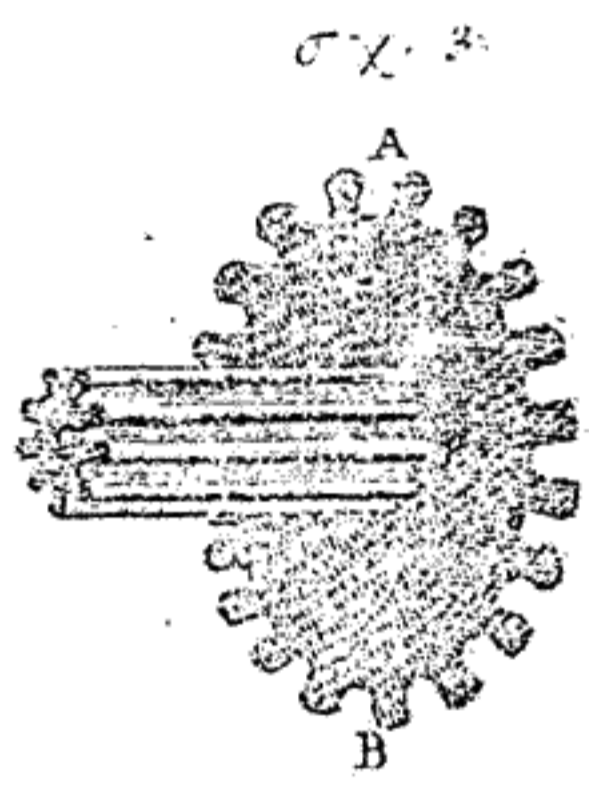
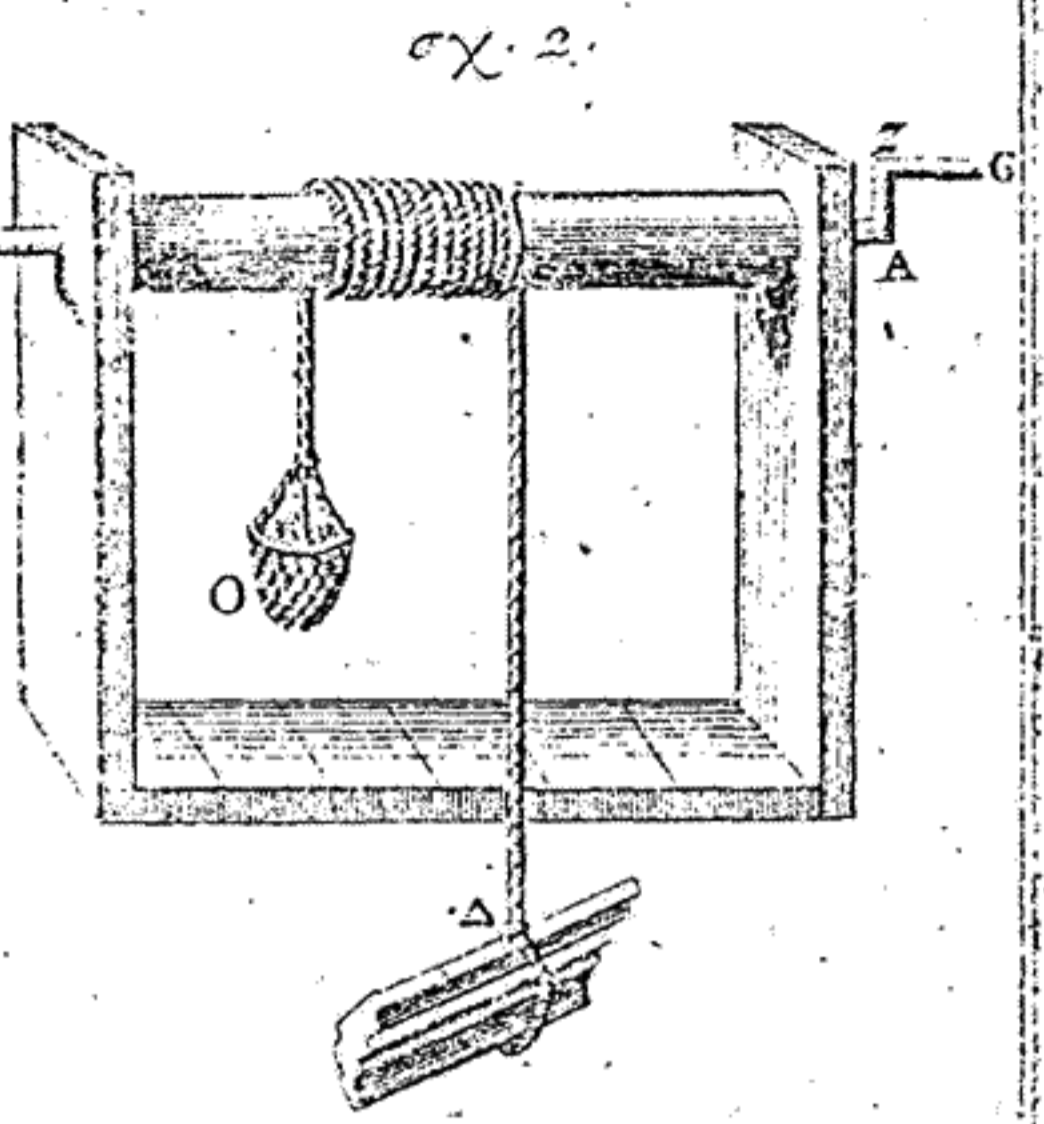
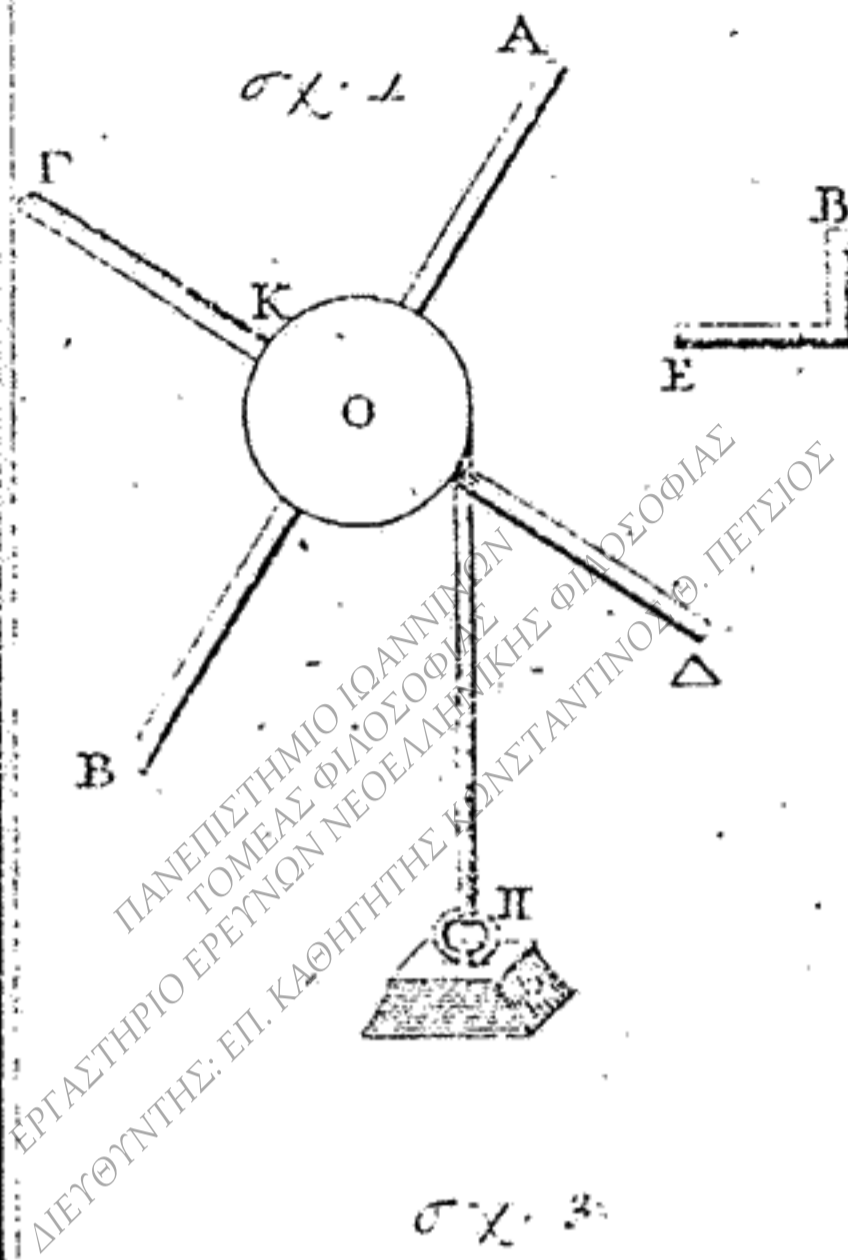

ΠΑΝΕΠΙΣΤΗΜΙΟ ΙΩΑΝΝΙΝΩΝ
 ΤΟΜΕΑΣ ΦΙΛΟΣΟΦΙΑΣ
 ΕΡΓΑΣΤΗΡΙΟ ΕΡΕΥΝΩΝ ΝΕΟΕΛΛΗΝΙΚΗΣ ΦΙΛΟΣΟΦΙΑΣ
 ΔΙΕΥΘΥΝΤΗΣ: ΕΠ. ΚΑΘΗΓΗΤΗΣ ΚΩΝΣΤΑΝΤΙΝΟΣ Θ. ΠΕΤΣΙΟΣ

Ε.Υ.Δ της Κ.τ.Π
 ΙΩΑΝΝΙΝΑ 2005

σχ. 1.

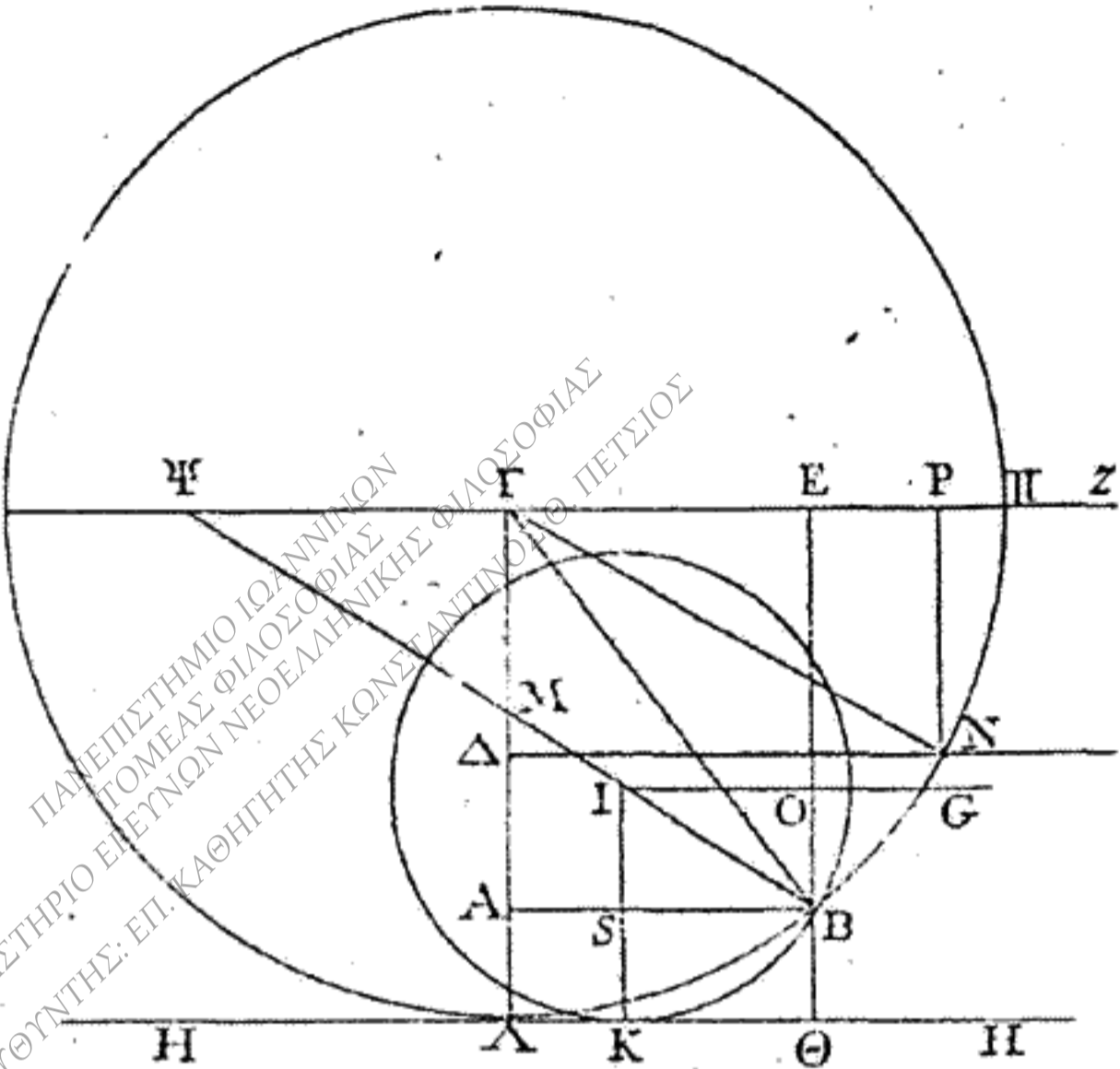

σχ. 2.

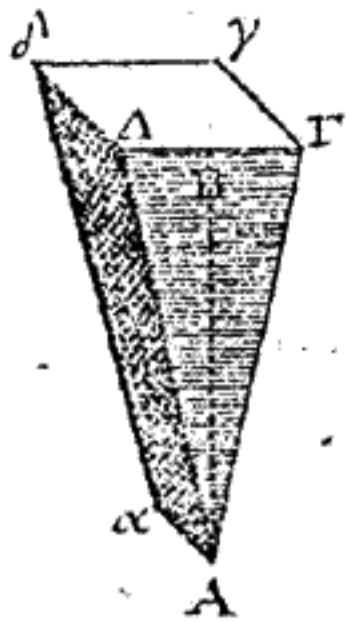

σχ. 4.

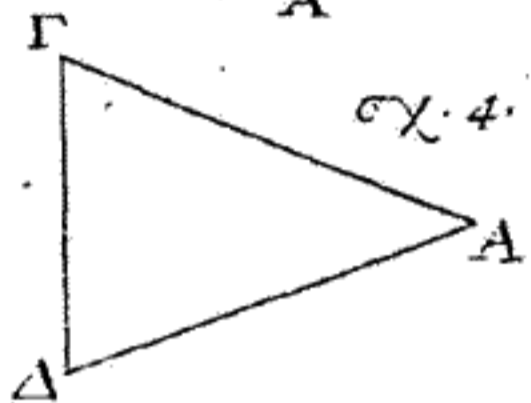

σχ. 5.

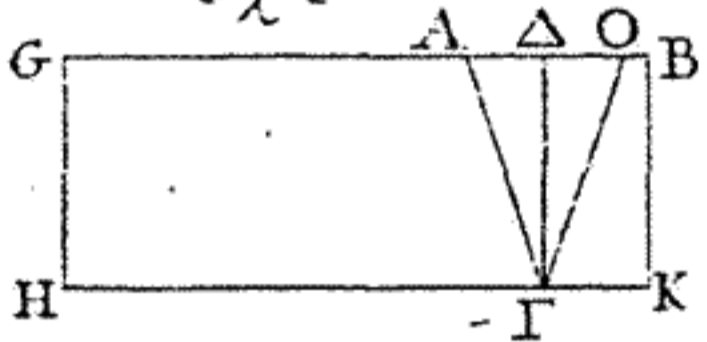

σχ. 3.

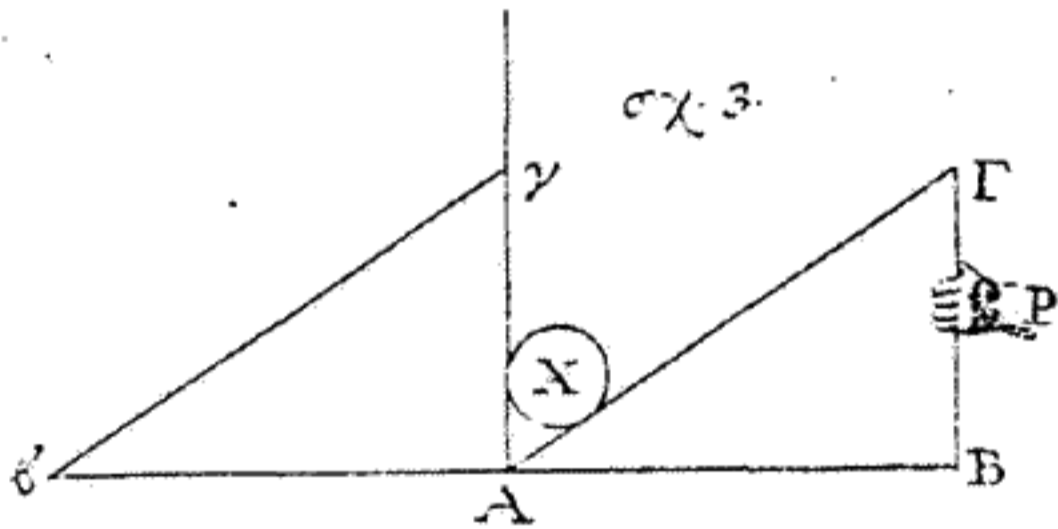

σχ. 6.

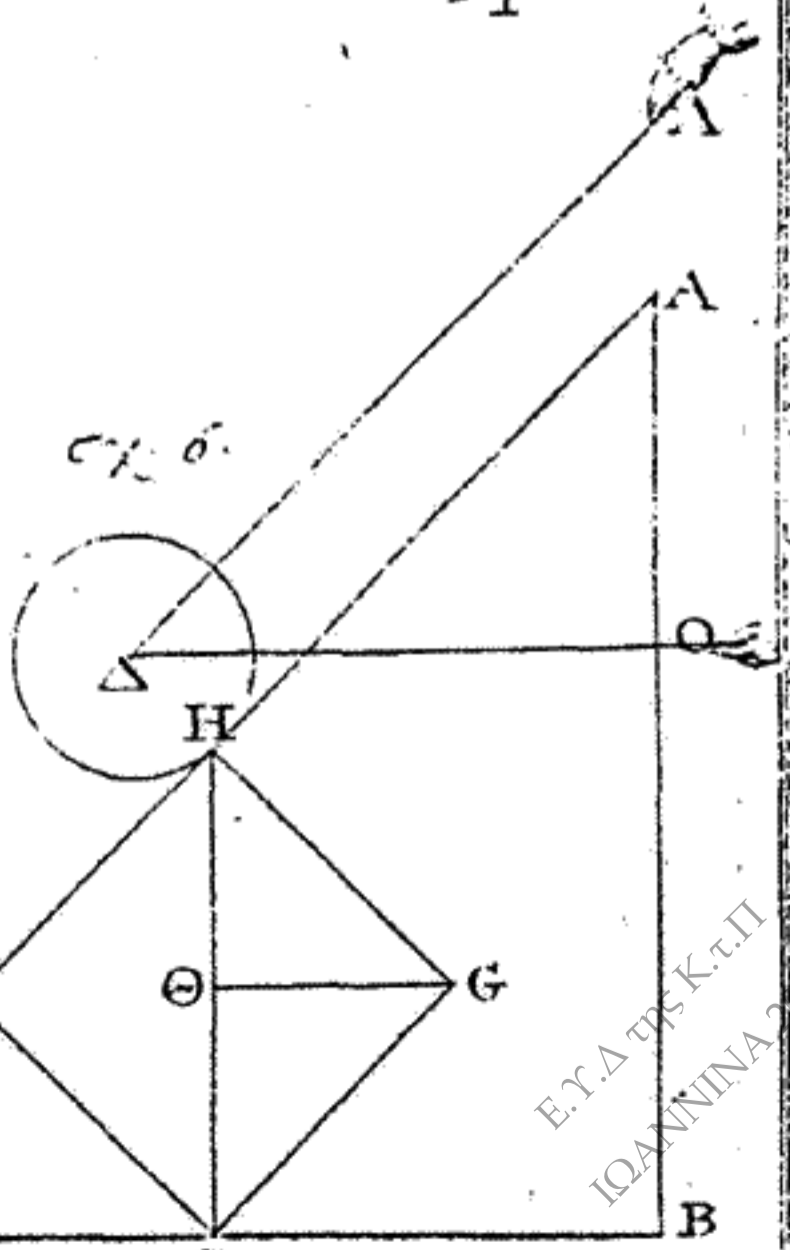

σχ. 7.

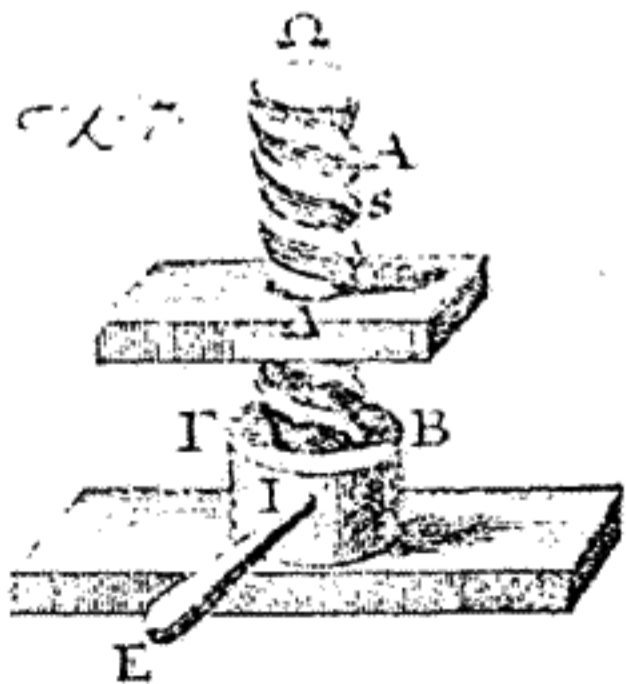

Ε.Υ.Δ. ΤΗΣ Κ.Τ.Π.
 ΙΩΑΝΝΙΝΑ 2006

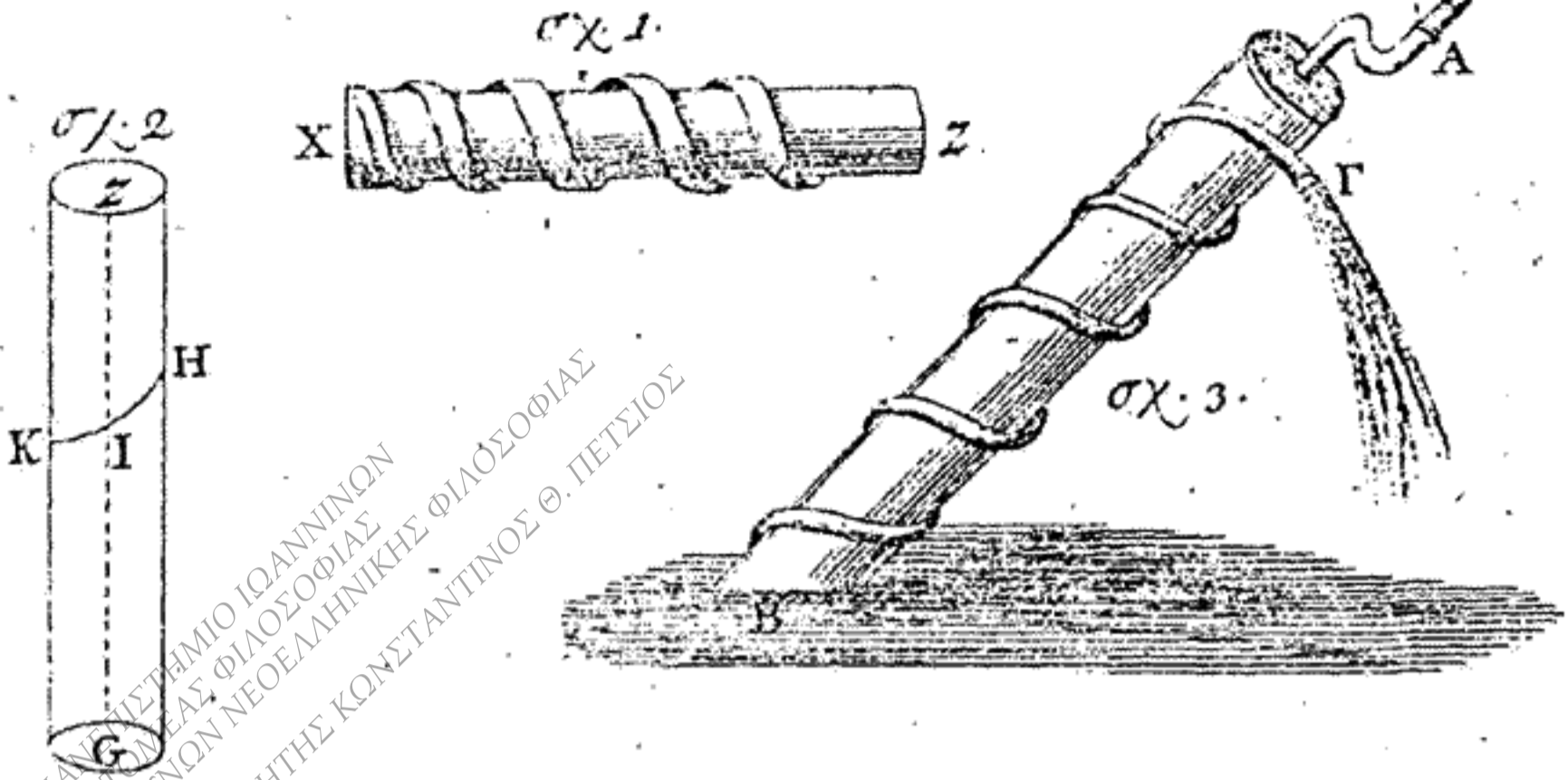

ΠΑΝΕΠΙΣΤΗΜΙΟ ΙΩΑΝΝΙΝΩΝ
 ΤΜΗΜΑ ΦΙΛΟΣΟΦΙΑΣ
 ΕΡΓΑΣΤΗΡΙΟ ΕΡΕΥΝΩΝ ΝΕΟΕΛΛΗΝΙΚΗΣ ΦΙΛΟΣΟΦΙΑΣ
 ΔΙΕΥΘΥΝΤΗΣ: ΕΠ. ΚΑΘΗΓΗΤΗΣ ΚΩΝΣΤΑΝΤΙΝΟΣ Θ. ΠΕΤΣΙΟΣ

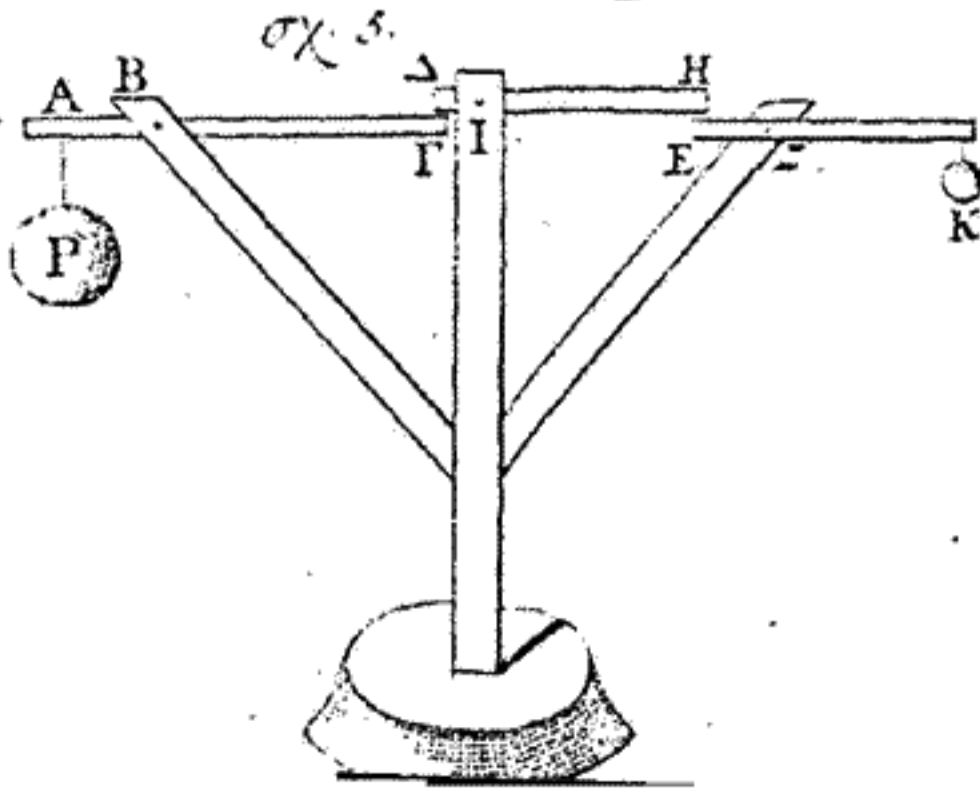
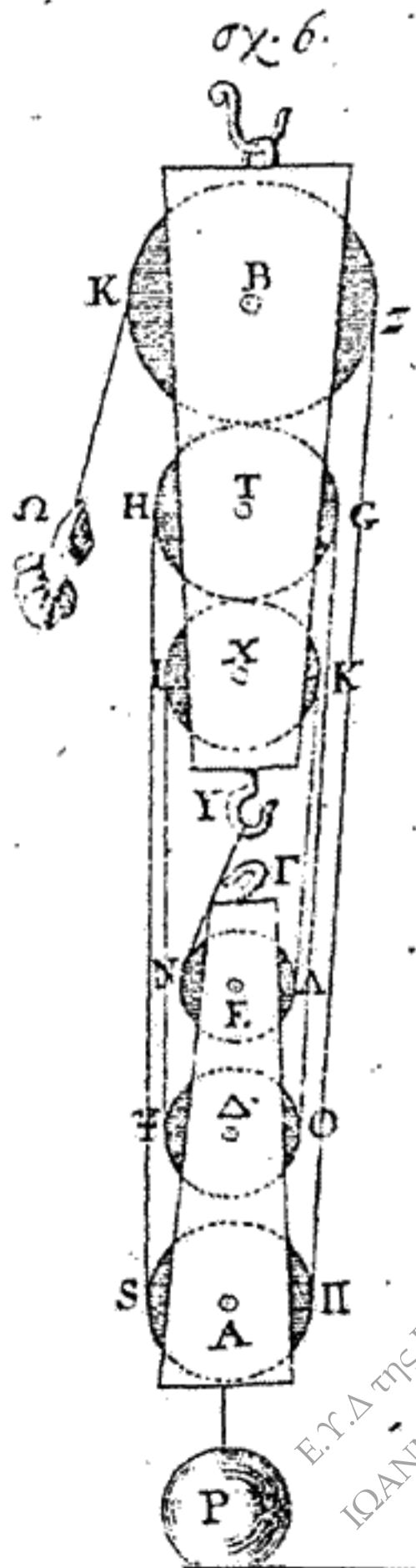
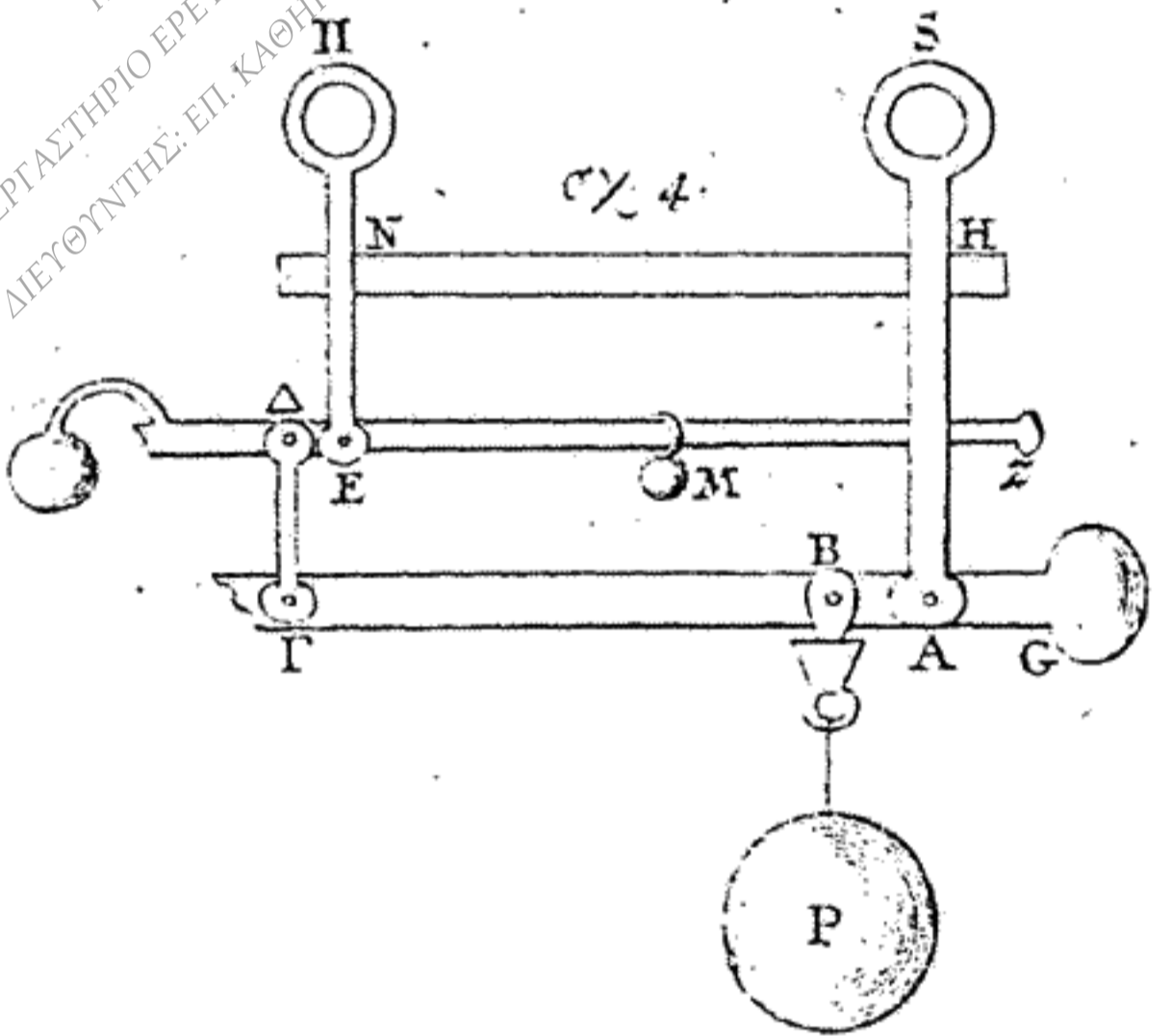

Ε.Υ.Δ της Κ.Τ.Π.
 ΙΩΑΝΝΙΝΑ 2006

σχ. 1.

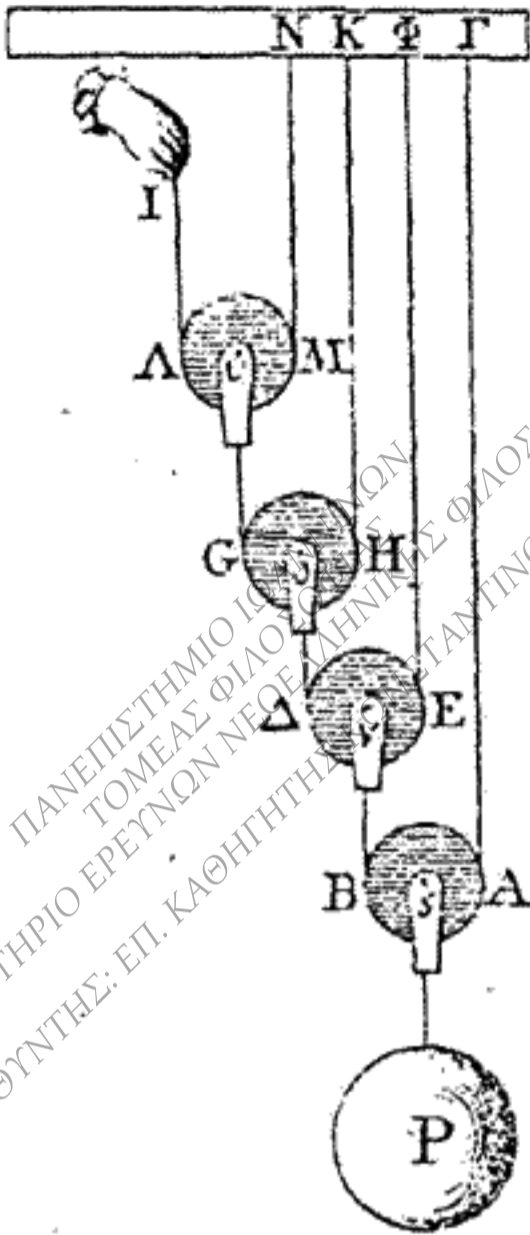

σχ. 2.

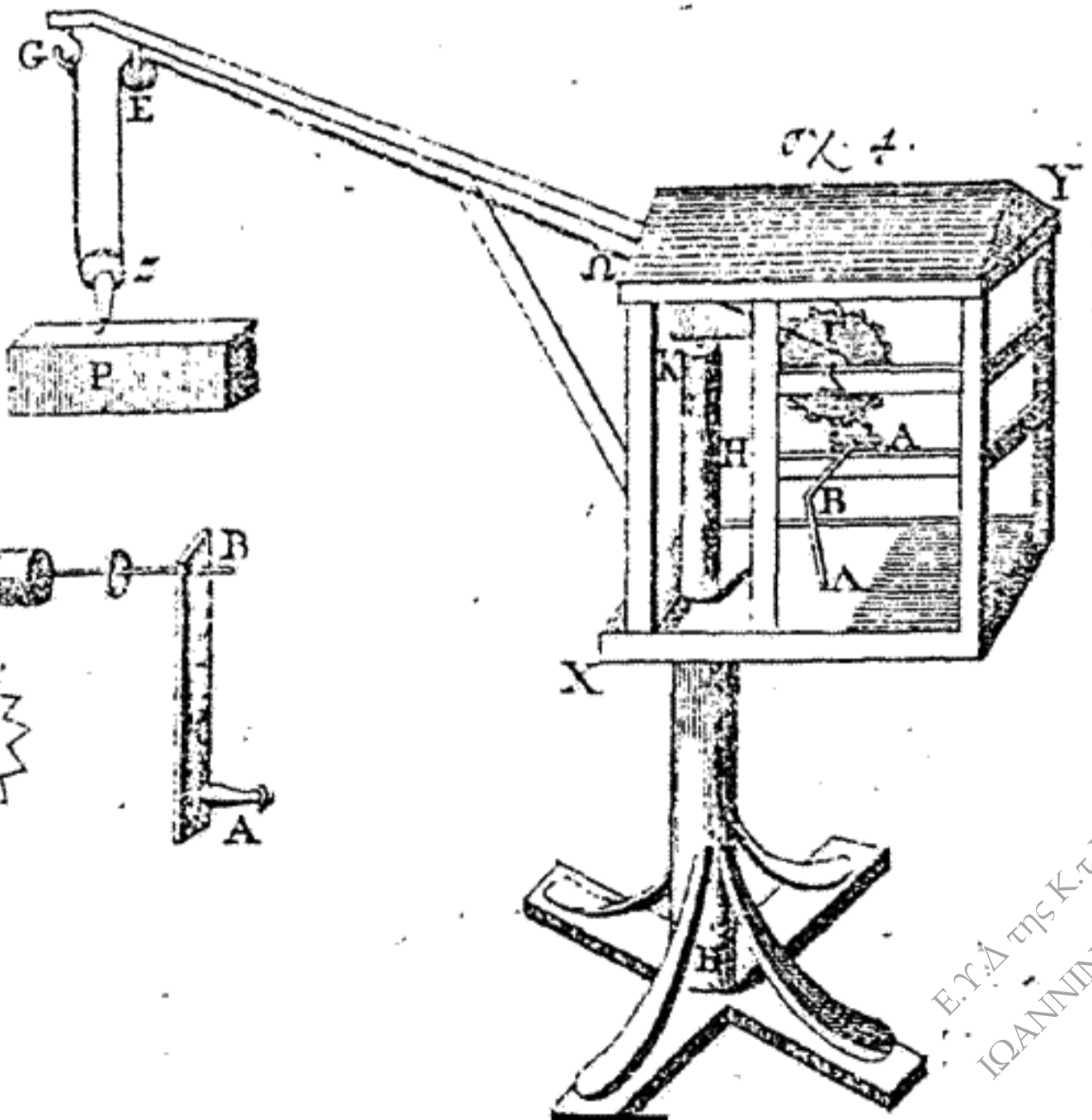
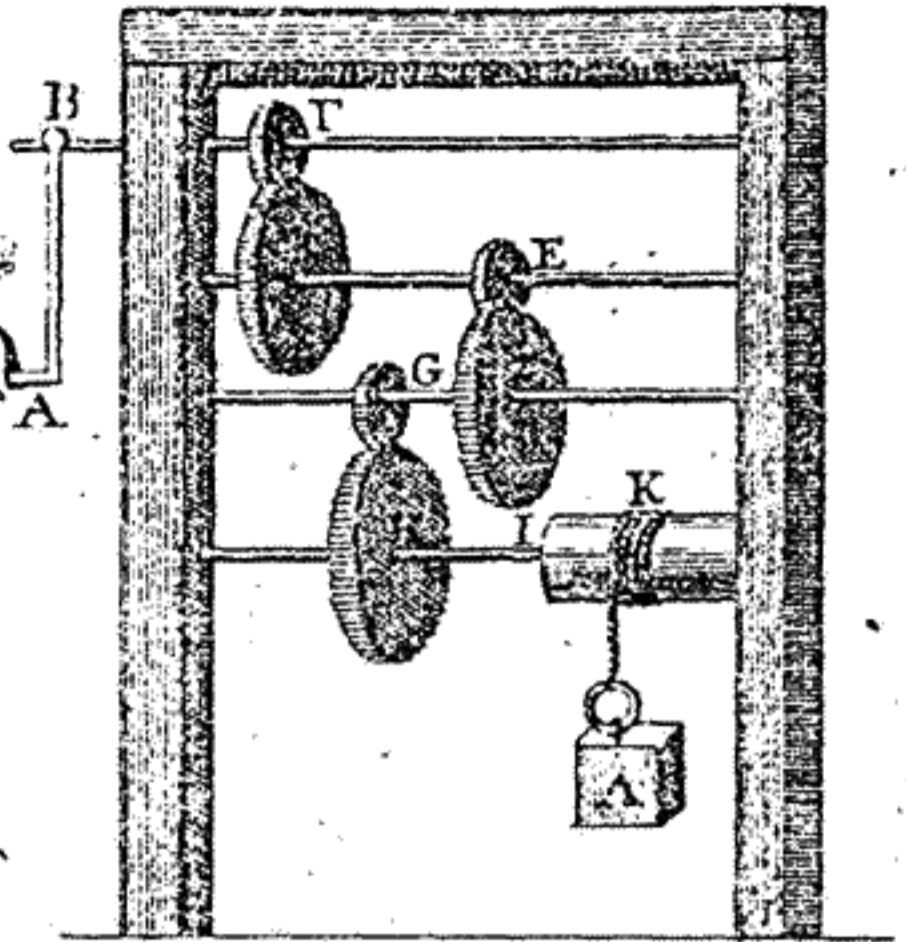

σχ. 3.

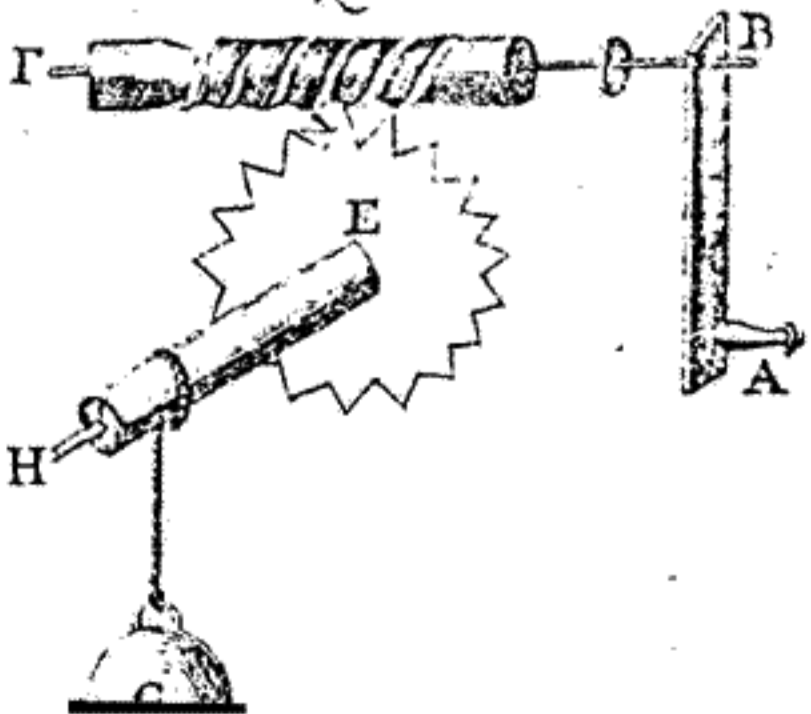

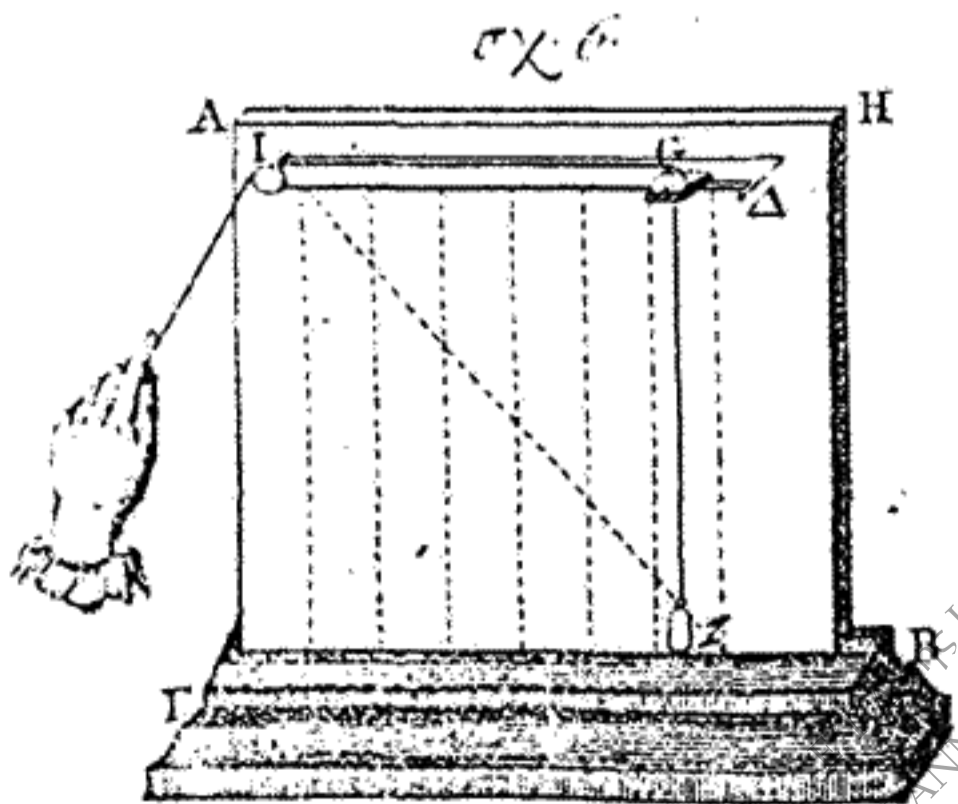
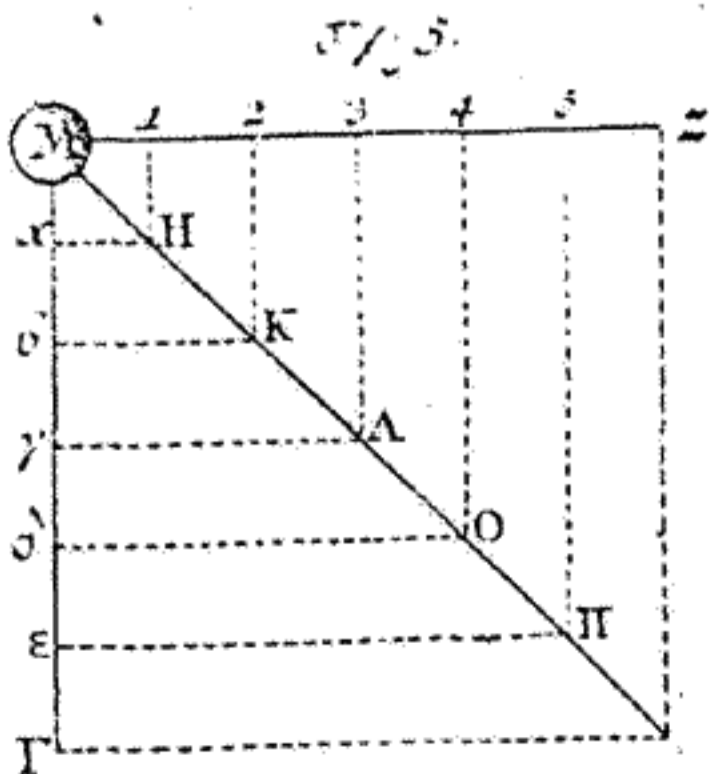
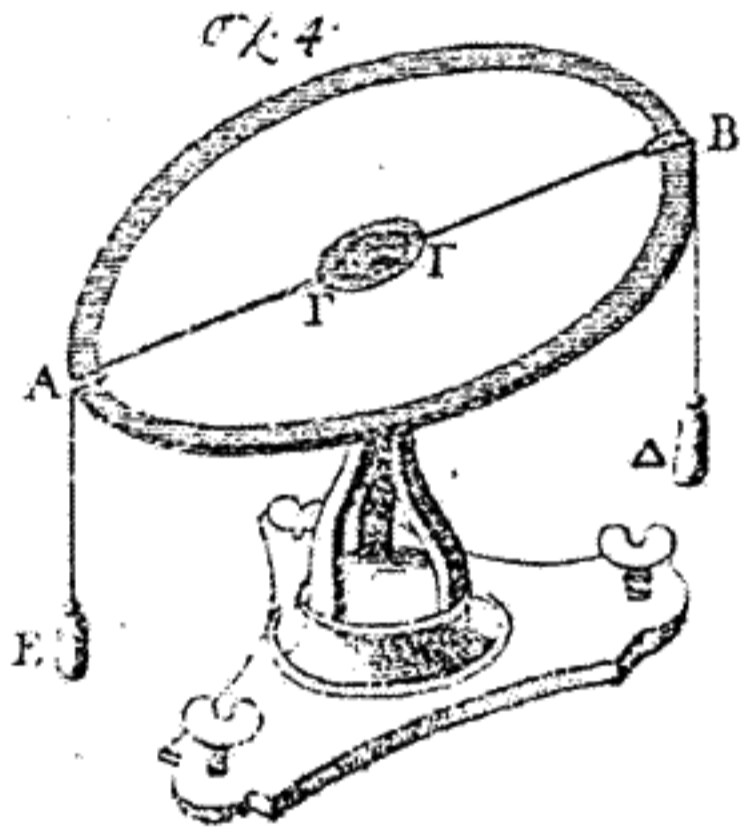
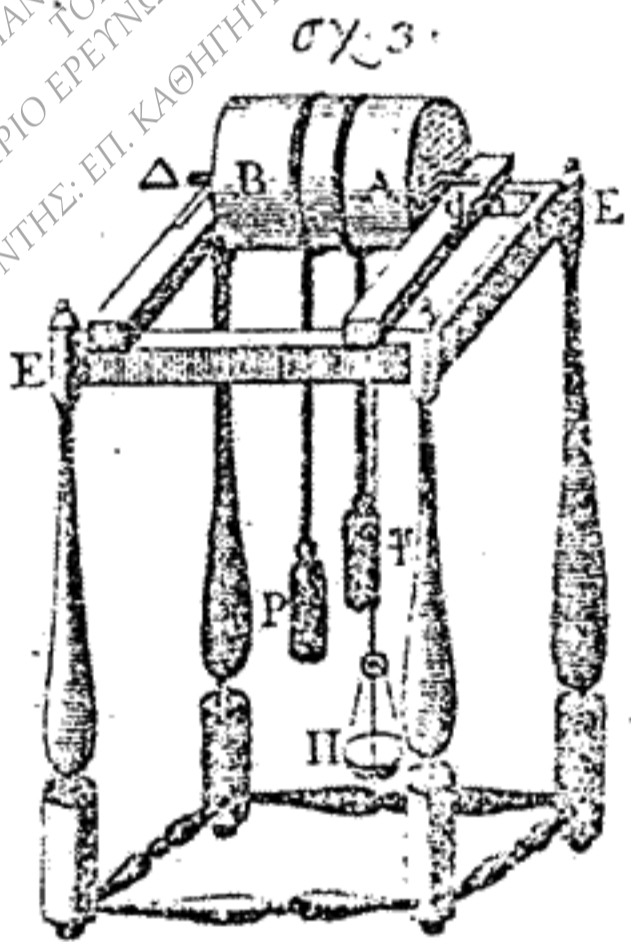
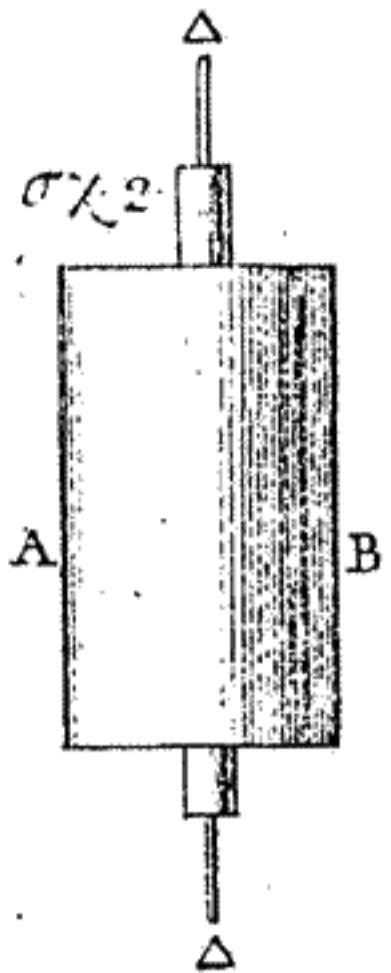
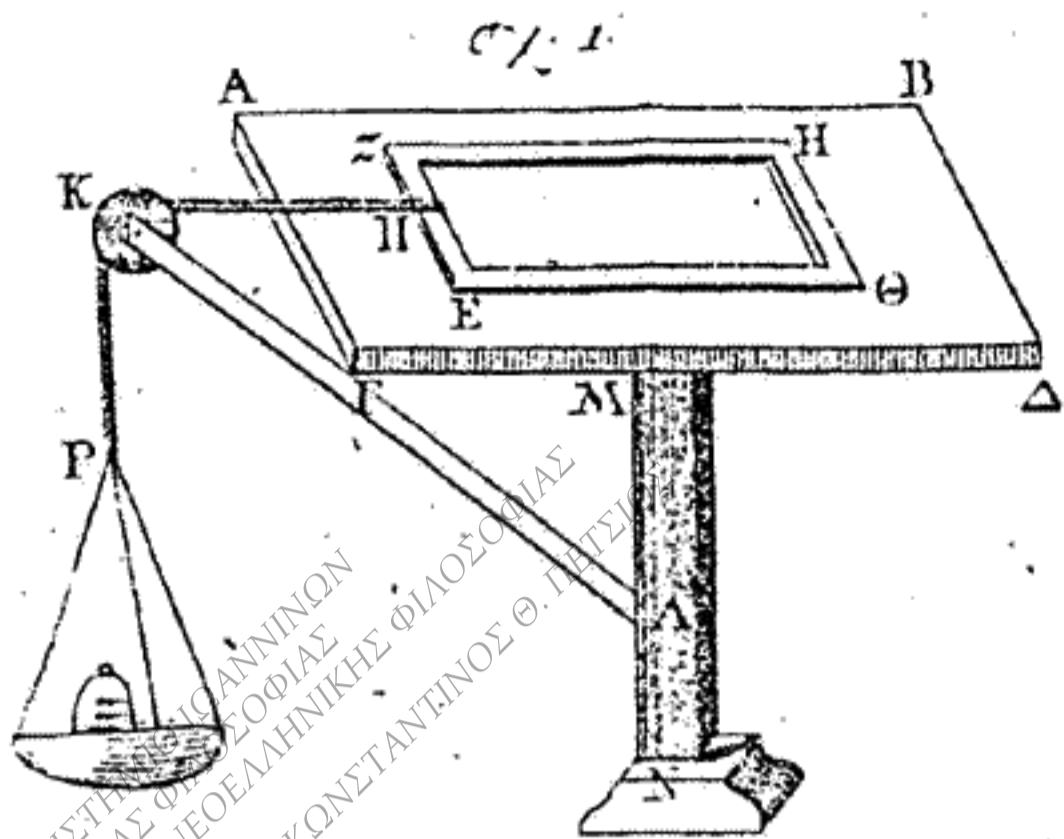

ΠΑΝΕΠΙΣΤΗΜΙΟΝ ΙΚΑΝΝΙΝΩΝ
 ΤΟΜΕΑΣ ΦΙΛΟΣΟΦΙΑΣ
 ΕΡΓΑΣΤΗΡΙΟ ΕΡΕΥΝΩΝ ΝΕΟΕΛΛΗΝΙΚΗΣ ΦΙΛΟΣΟΦΙΑΣ
 ΔΙΕΥΘΥΝΤΗΣ: ΕΠ. ΚΑΘΗΓΗΤΗΣ ΚΩΝΣΤΑΝΤΙΝΟΣ Θ. ΠΕΤΣΙΔΗΣ

Κ.τ.Π.
 ΙΚΑΝΝΙΝΑ 2020

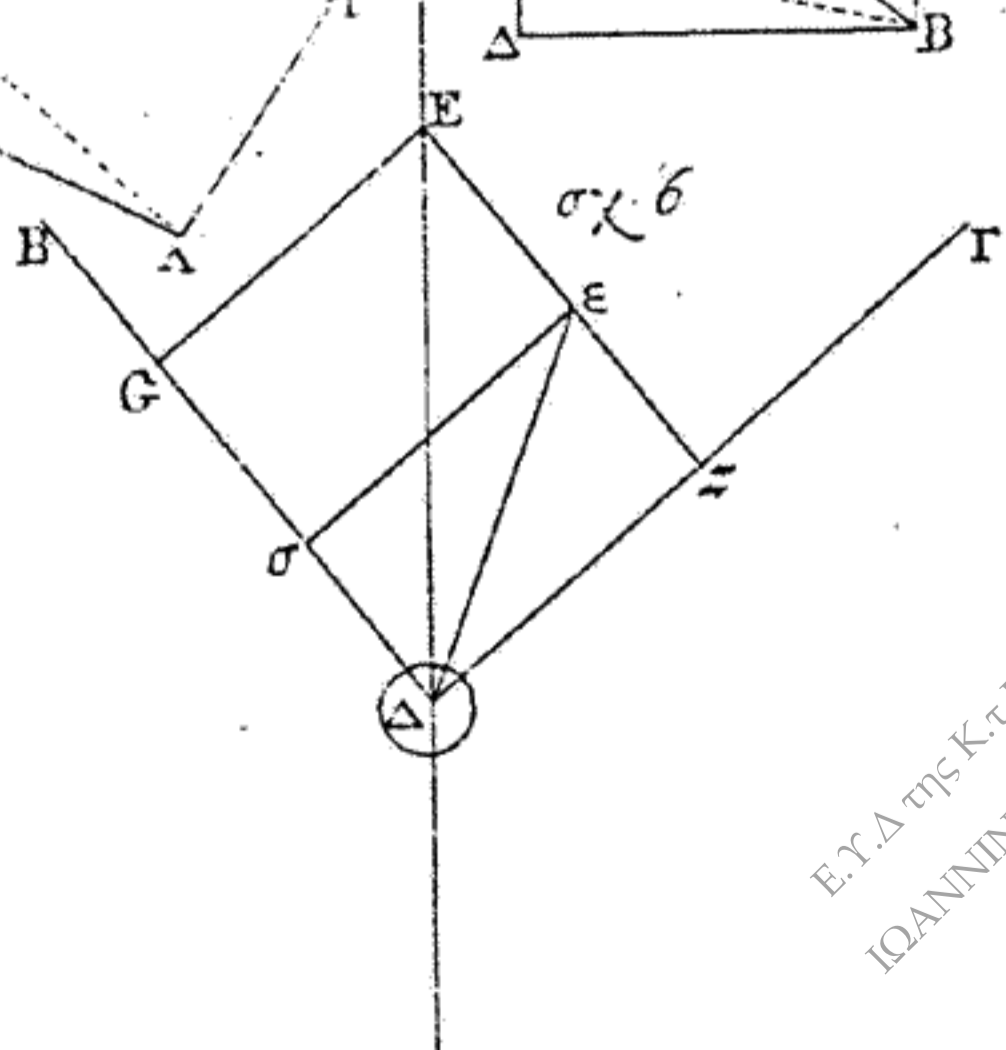
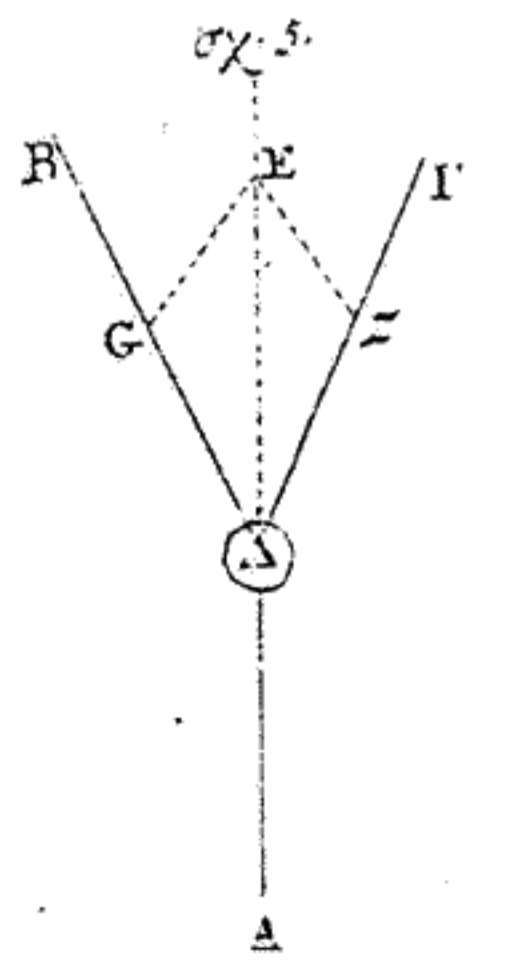
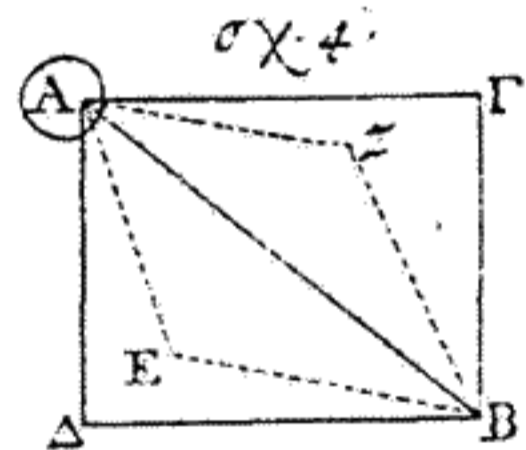
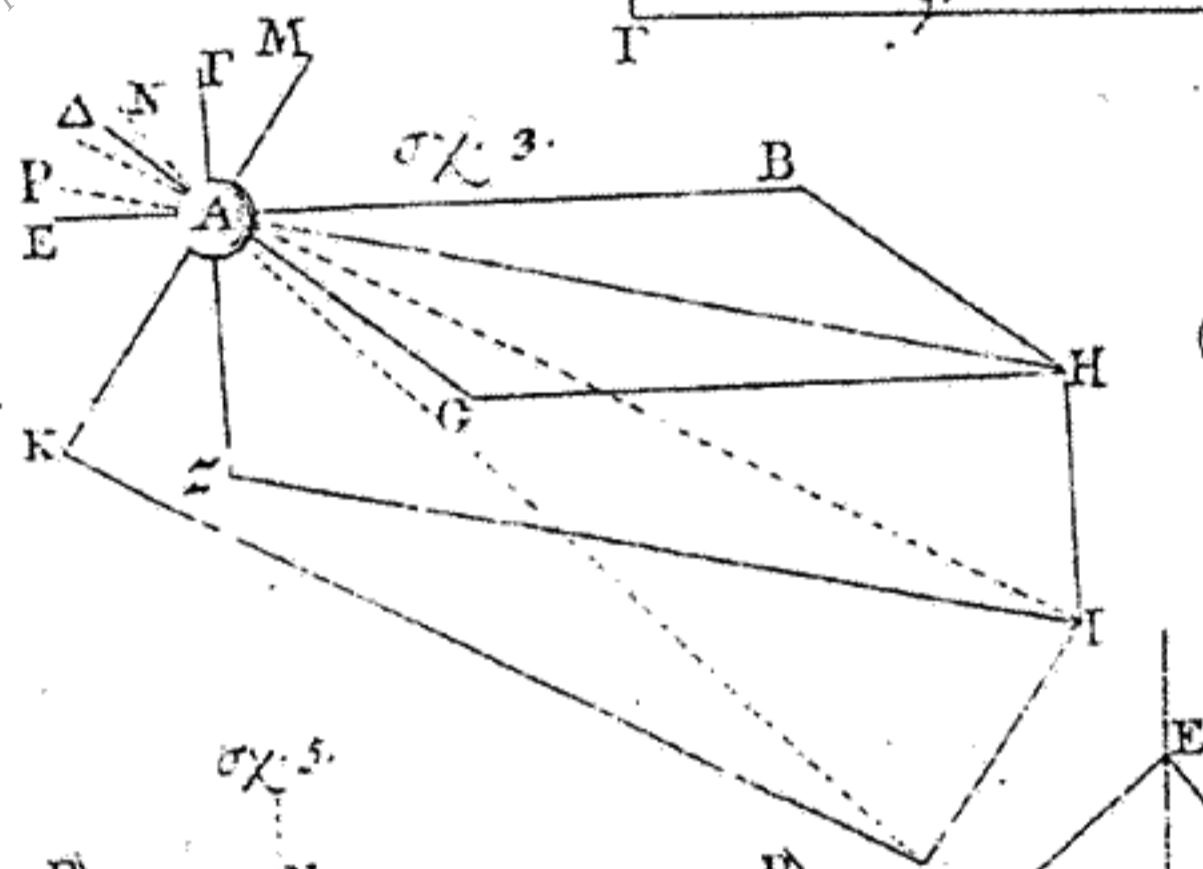
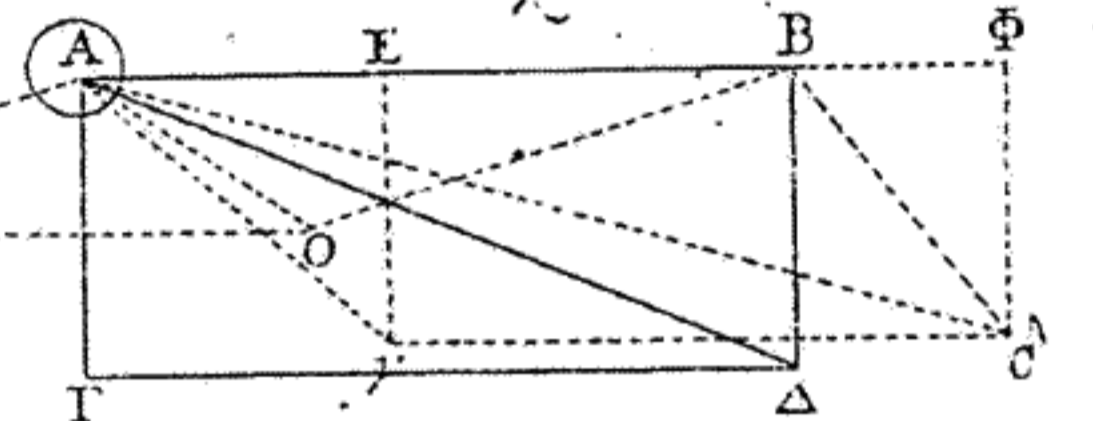
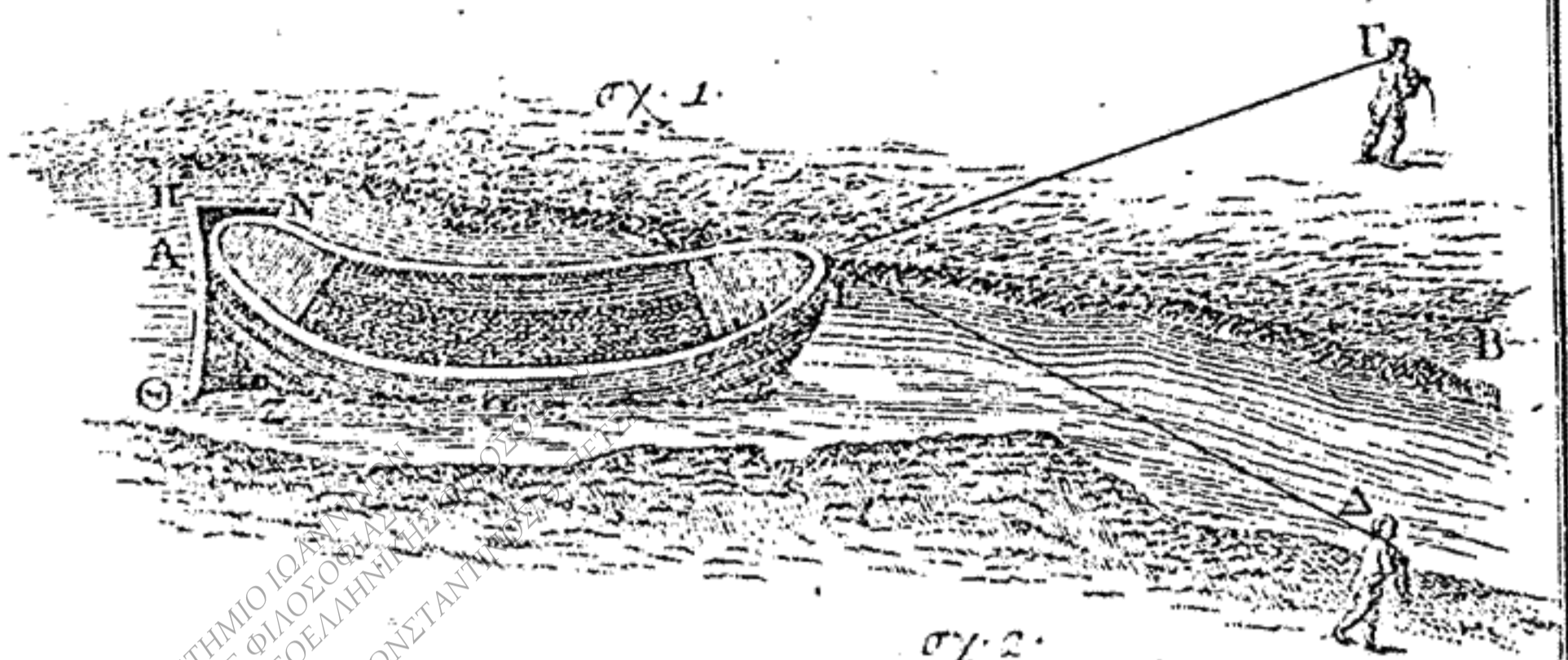

ΠΑΝΕΠΙΣΤΗΜΙΟ ΙΩΑΝΝΙΝΩΝ
 ΤΟΜΕΑΣ ΦΙΛΟΣΟΦΙΑΣ
 ΕΡΓΑΣΤΗΡΙΟ ΕΡΕΥΝΩΝ ΝΕΟΕΛΛΗΝΙΚΗΣ ΦΙΛΟΣΟΦΙΑΣ
 ΔΙΕΥΘΥΝΤΗΣ: Κ. ΚΑΘΗΓΗΤΗΣ ΚΩΝΣΤΑΝΤΙΝΟΣ ΠΑΠΑΔΟΠΟΥΛΟΣ

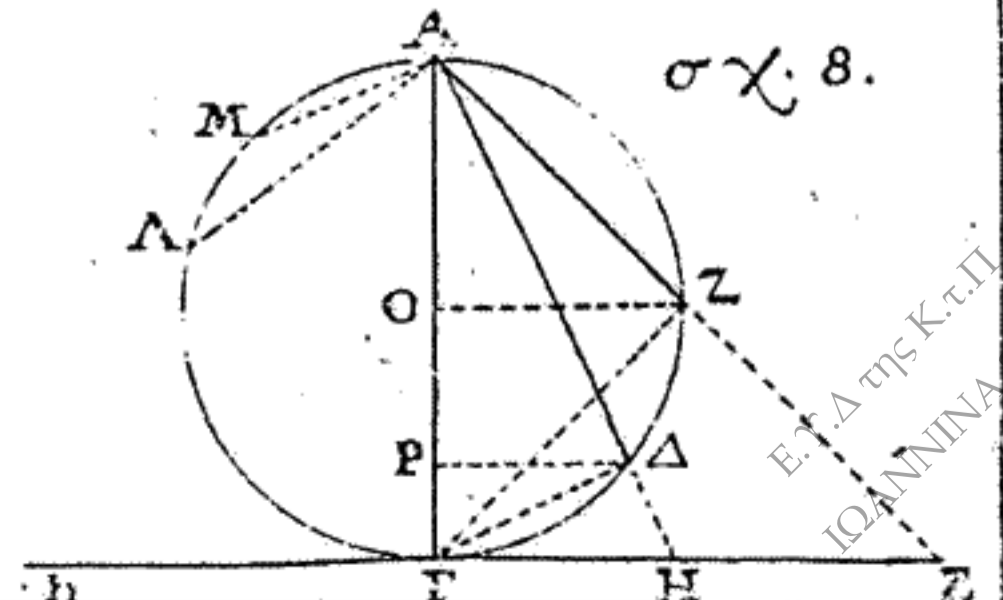
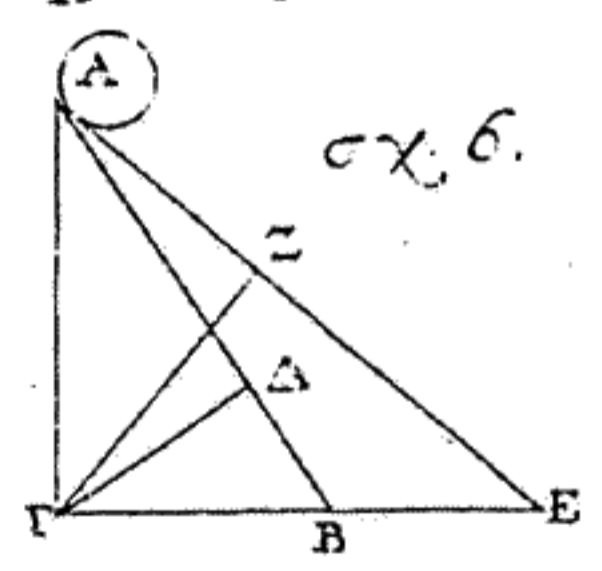
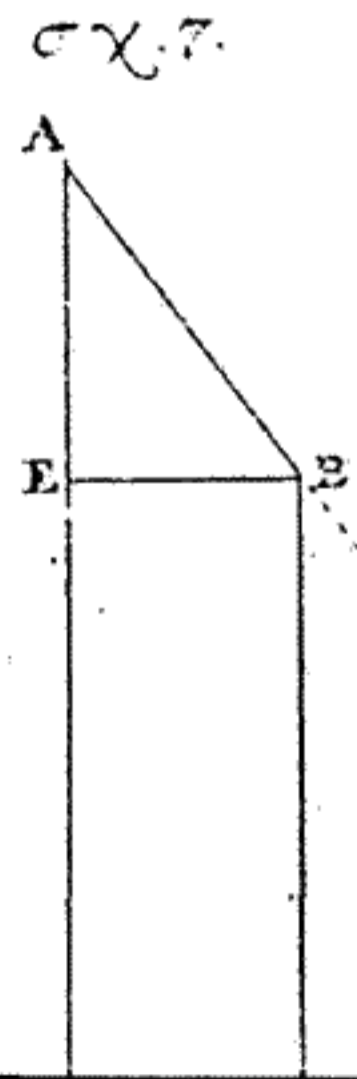
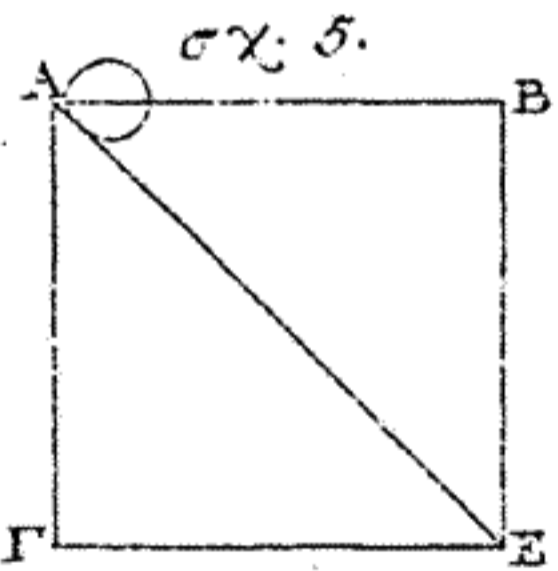
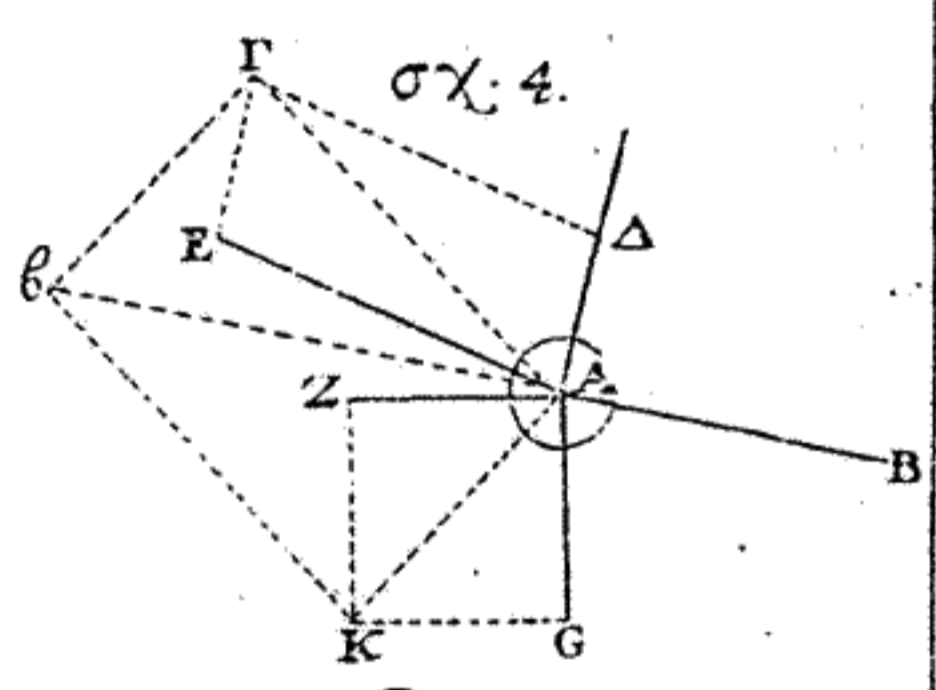
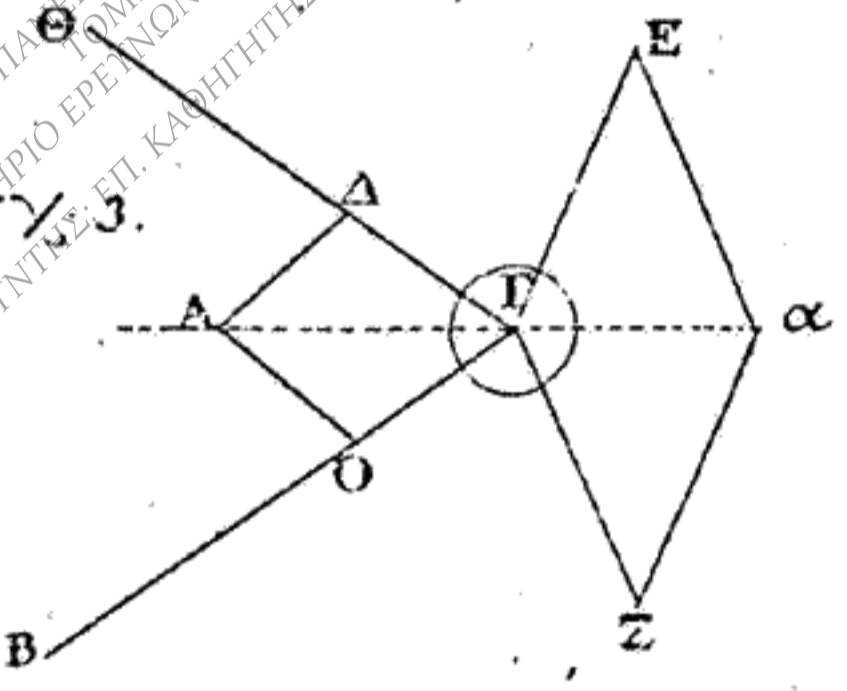
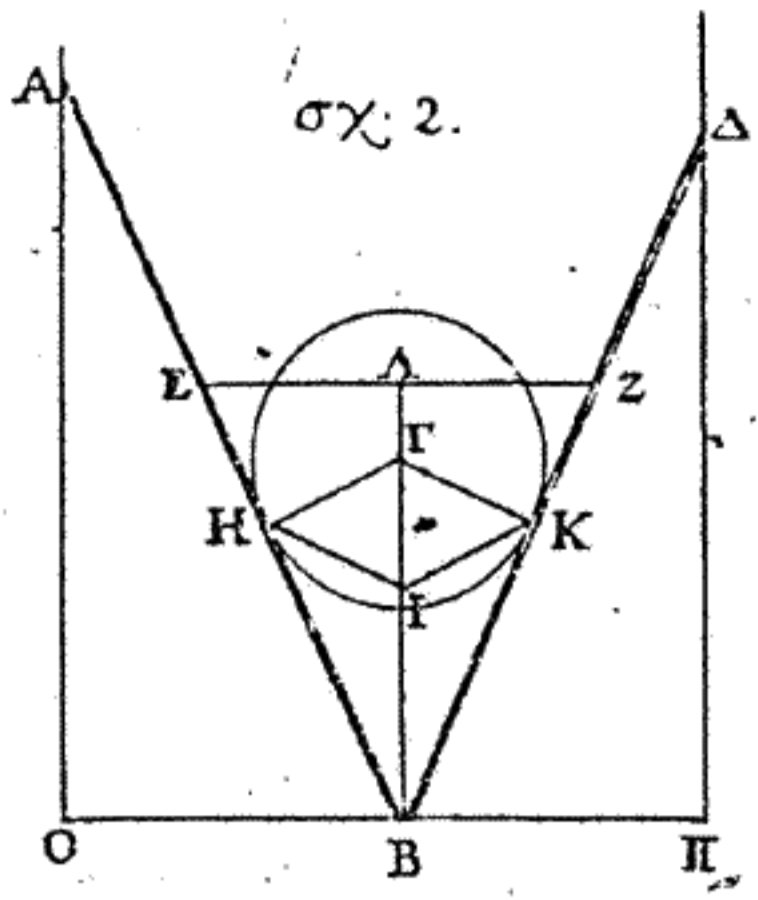
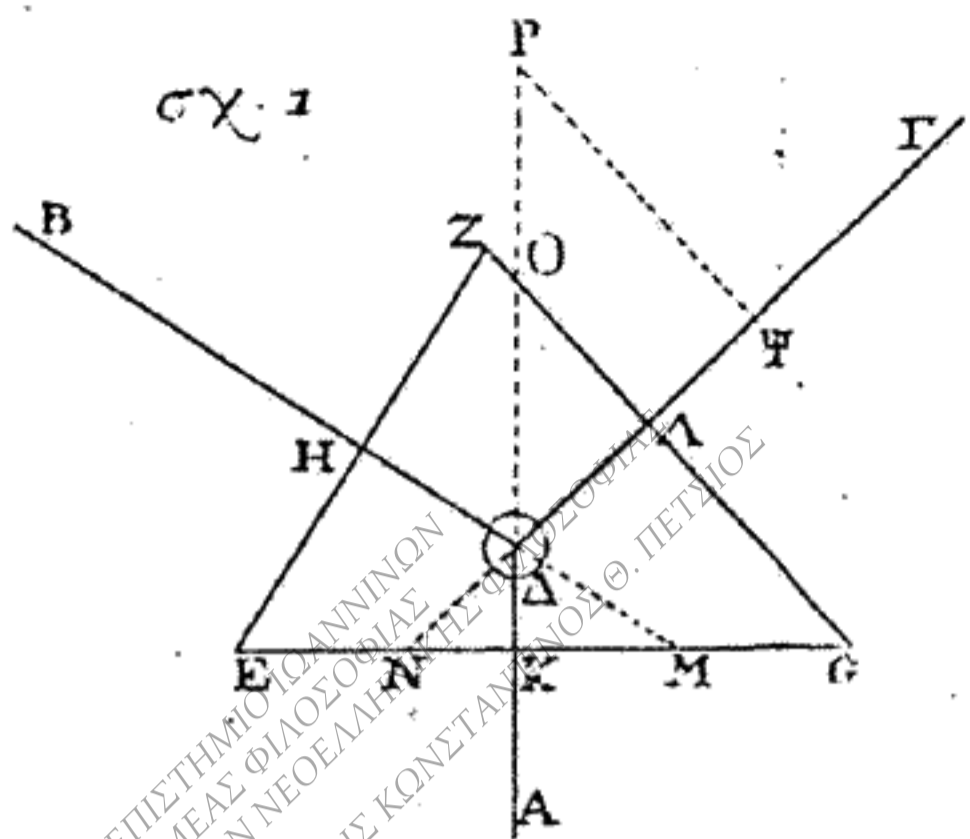

ΠΑΡΕΠΙΣΤΗΜΙΟ ΙΩΑΝΝΙΝΩΝ
 ΕΡΓΑΣΤΗΡΙΟ ΕΡΕΥΝΩΝ ΝΕΟΕΛΜΗΤΗΣ ΦΙΛΟΣΟΦΙΑΣ
 ΔΙΕΥΘΥΝΤΗΣ: ΠΡ. ΚΑΘΗΓΗΤΗΣ ΚΩΝΣΤΑΝΤΙΝΟΣ Θ. ΠΕΤΣΙΟΣ

Ε.Τ.Δ της Κ.τ.Π.
 ΙΩΑΝΝΙΝΑ 2006

σχ. 1.

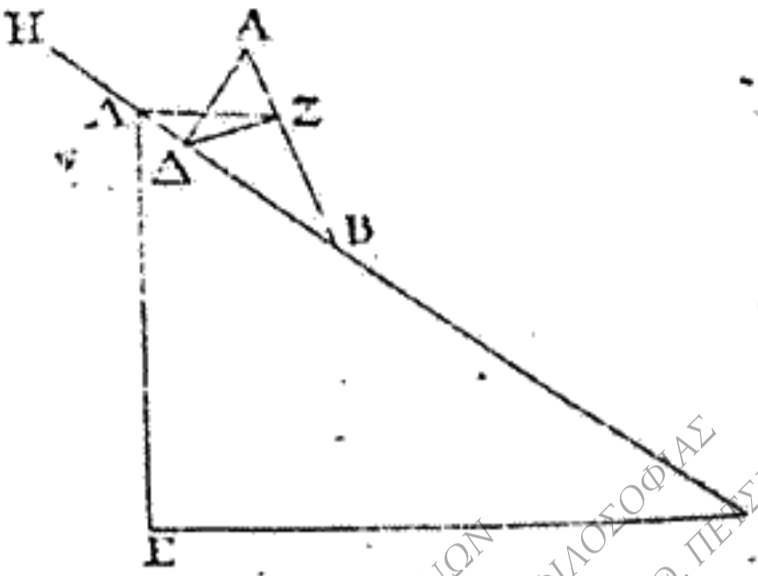

σχ. 2.

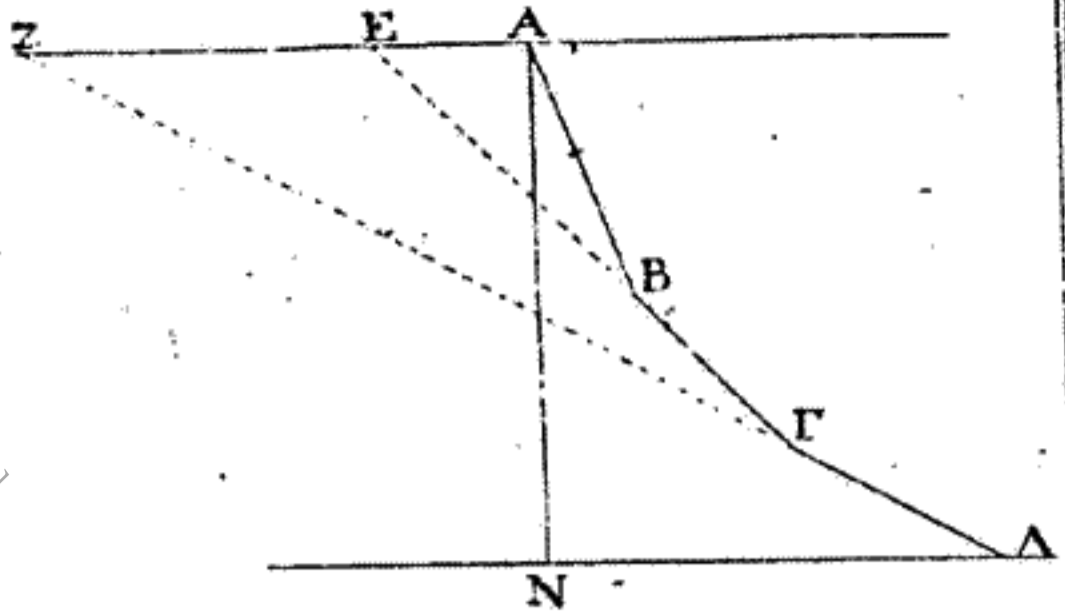

σχ. 3.

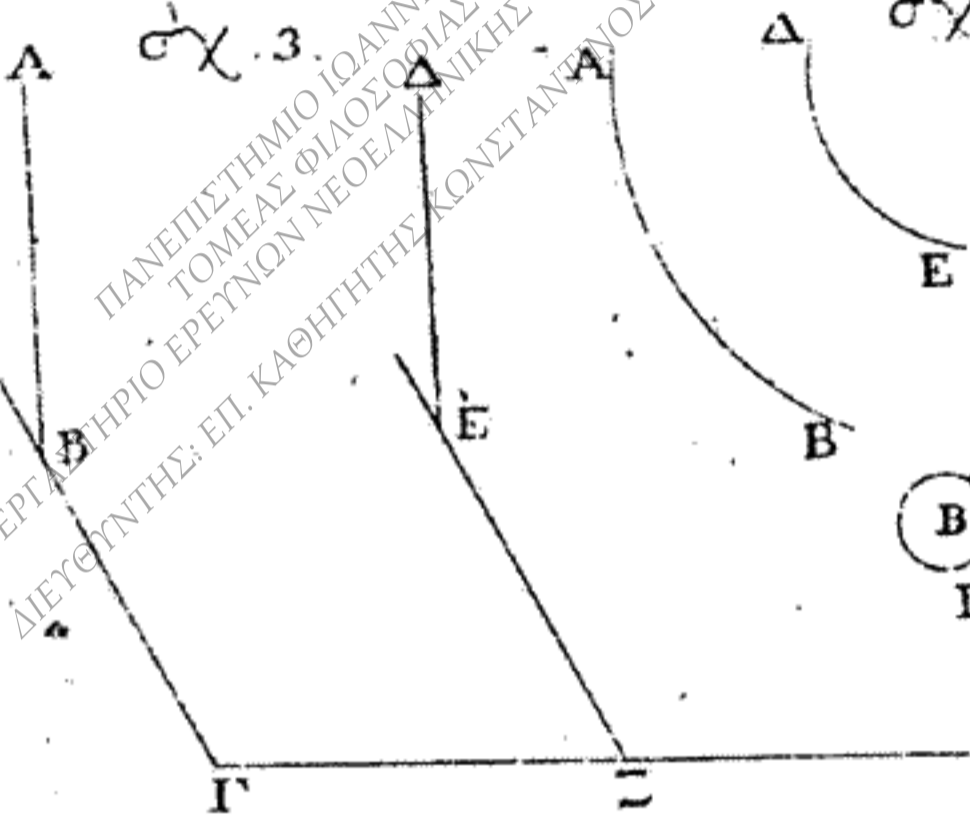

σχ. 4.

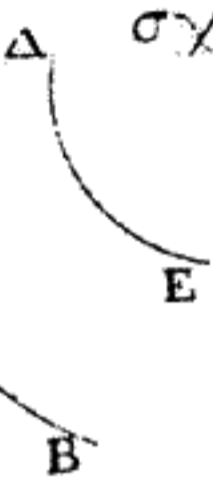

σχ. 5.

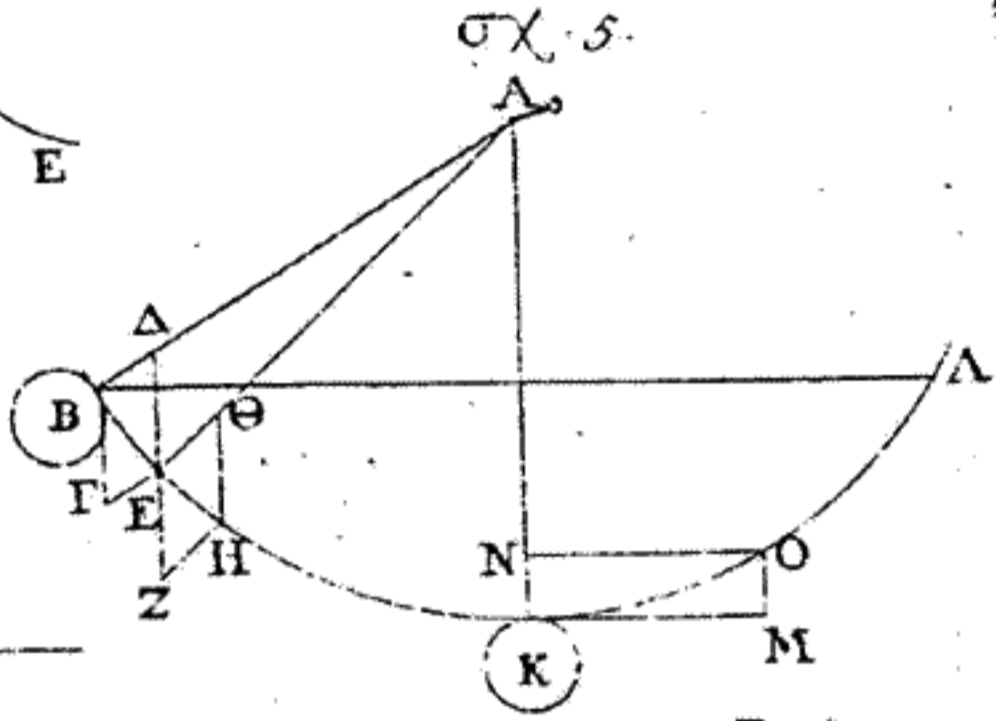

σχ. 6.

Γ₂



σχ. 9.

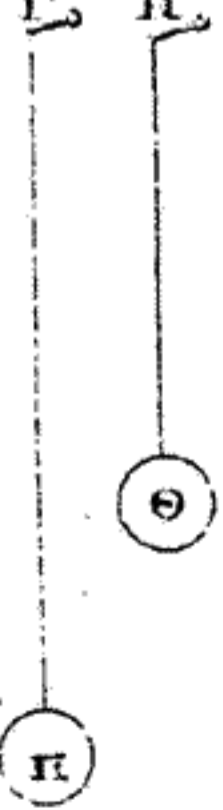

σχ. 10.

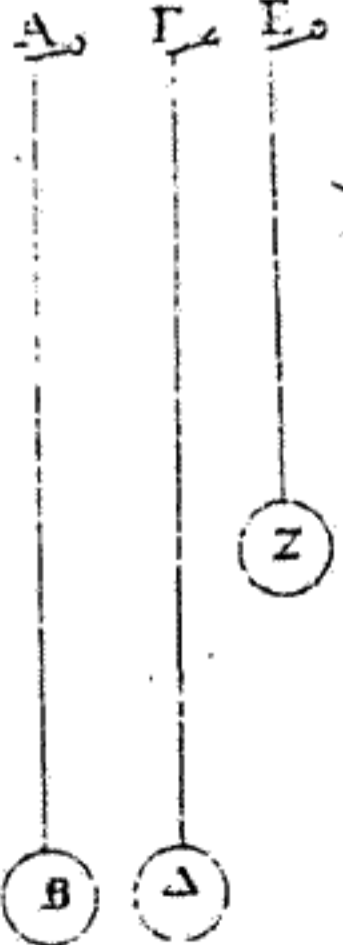

σχ. 7.

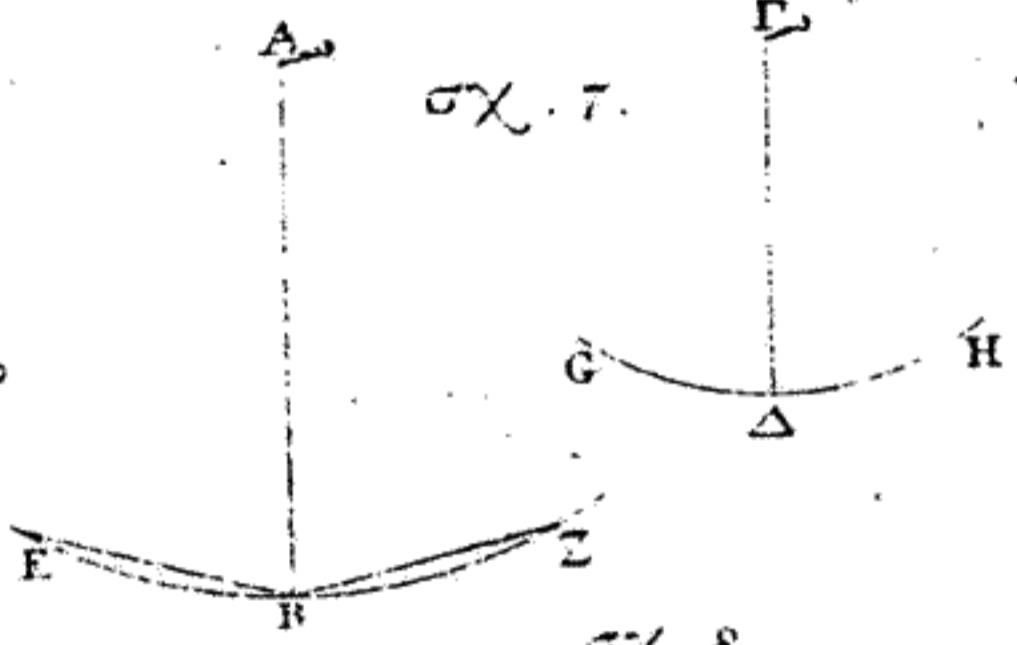

σχ. 8.

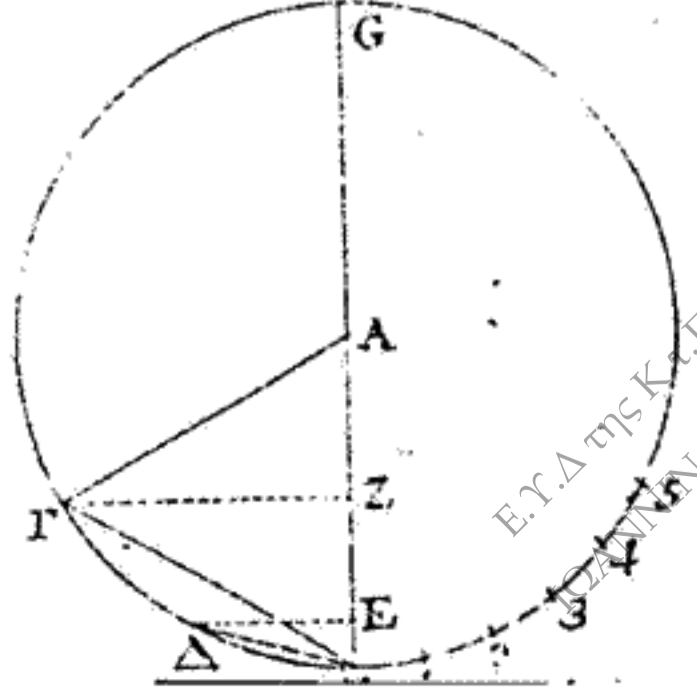

Ε.Υ.Δ της Κ.Ε.Π.
 ΙΩΑΝΝΙΝΑ 2006

σχ. 4

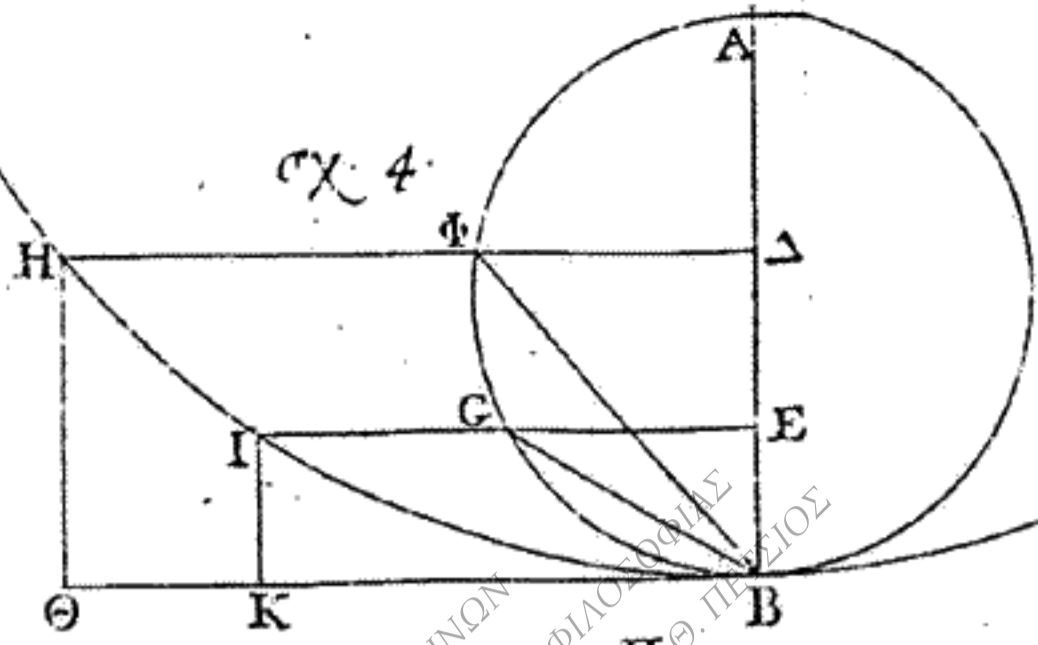

σχ. 5

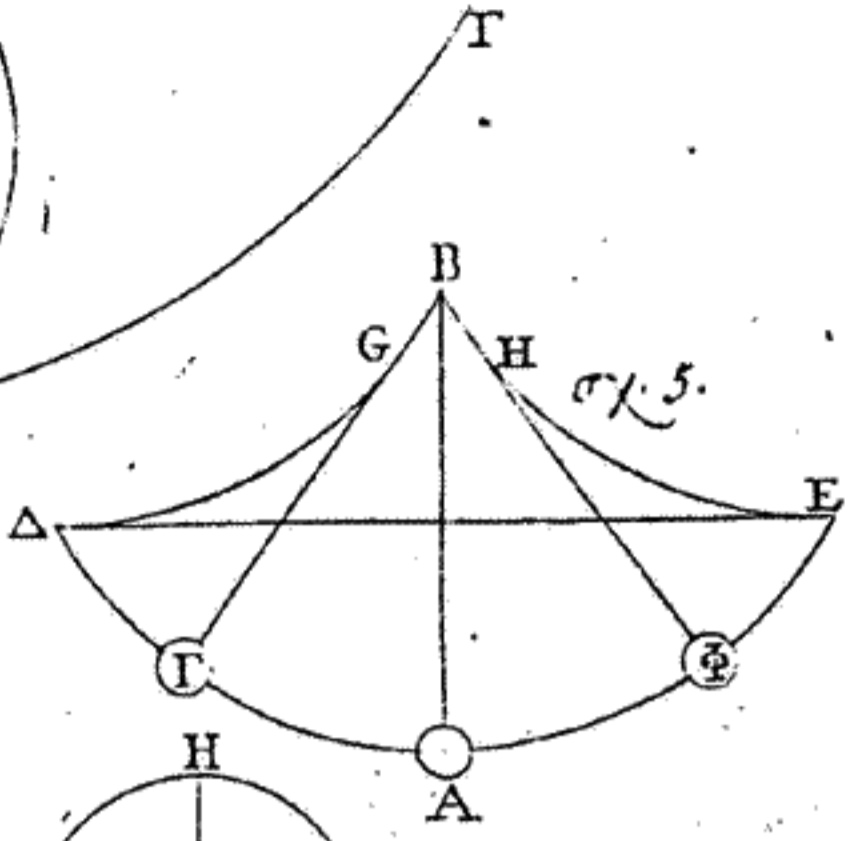

σχ. 1

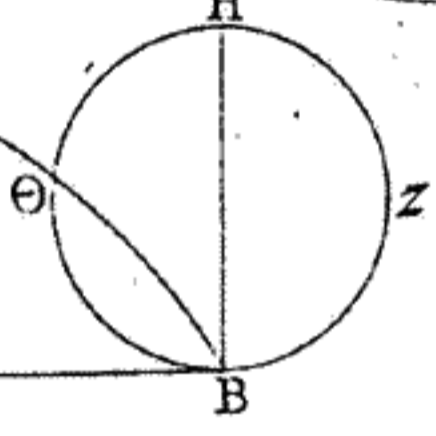
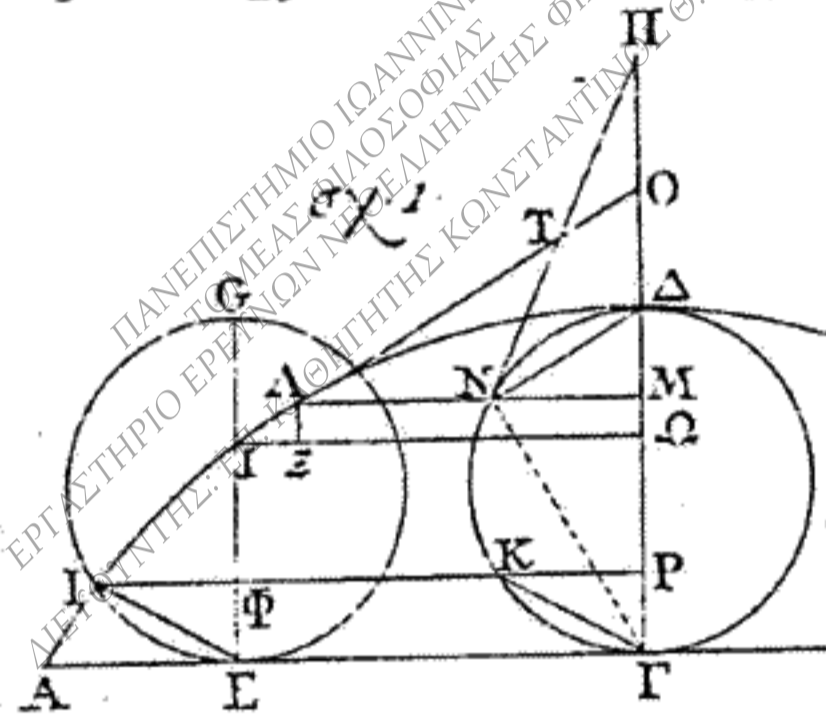

σχ. 6

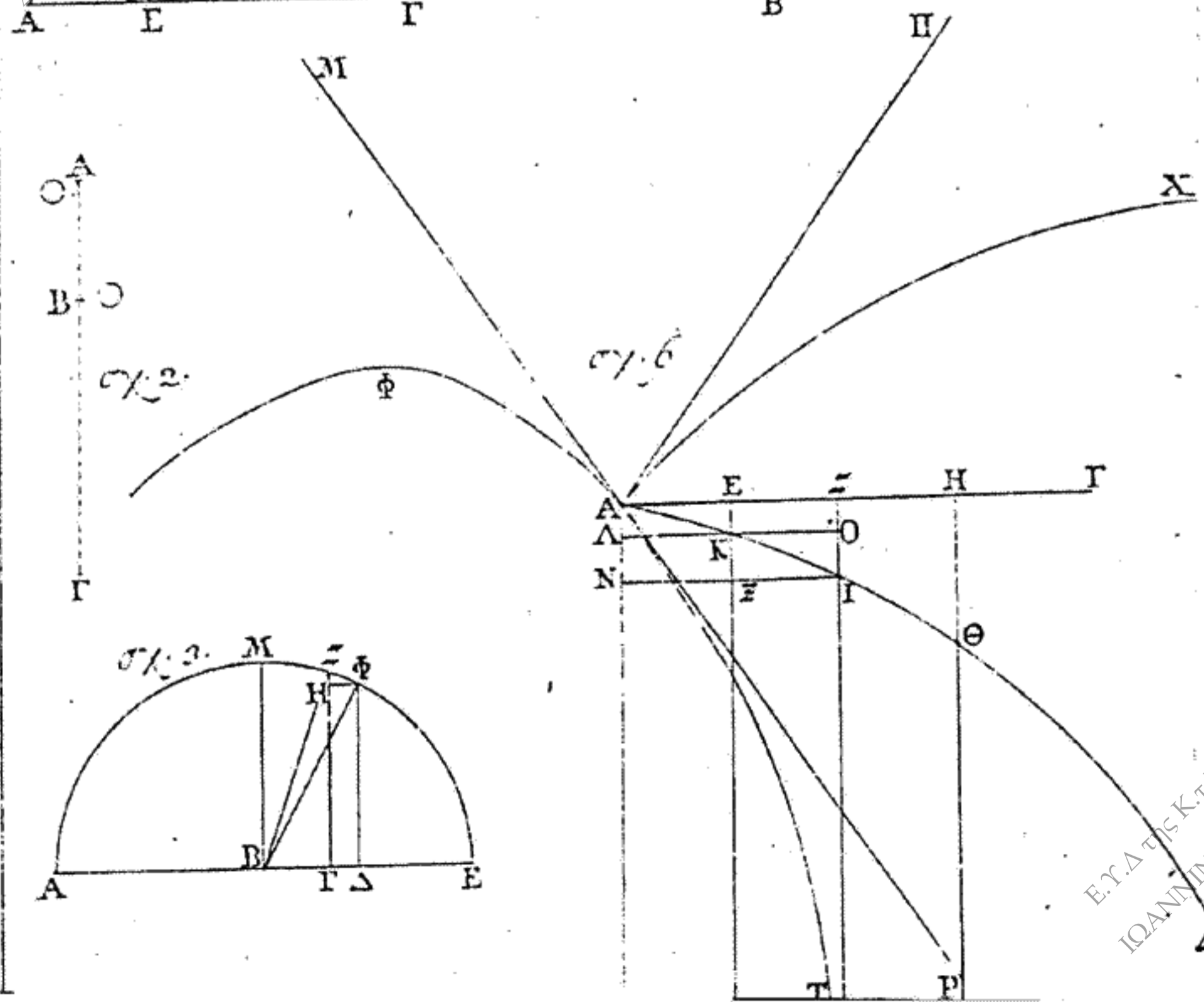

σχ. 2

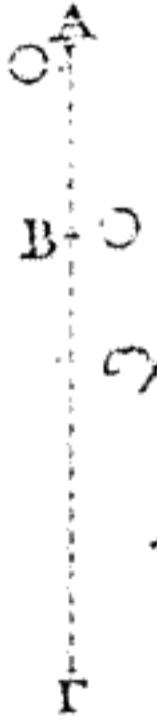

σχ. 3

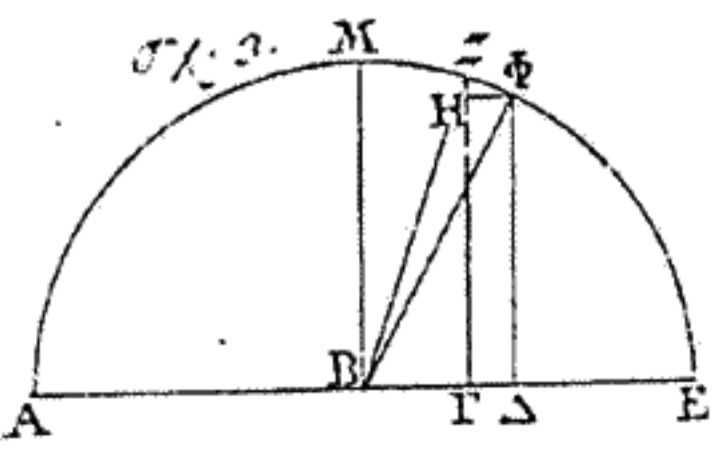

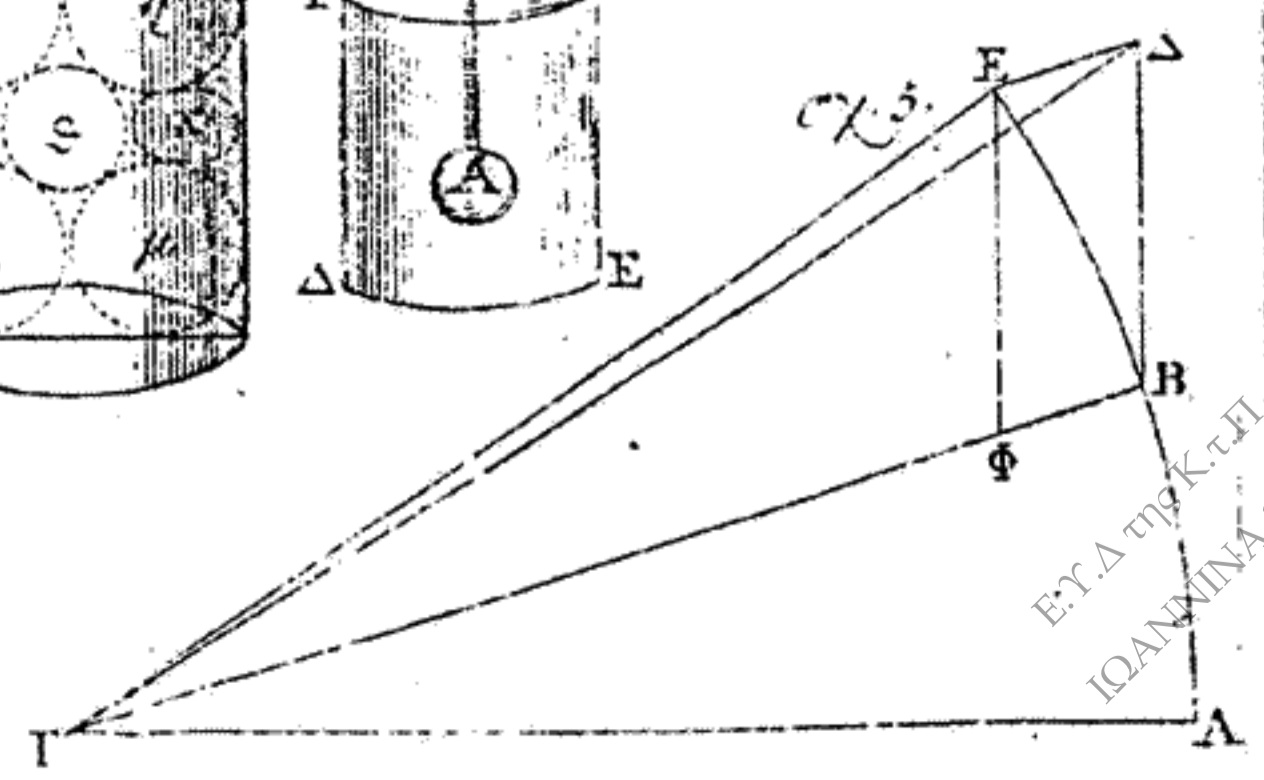
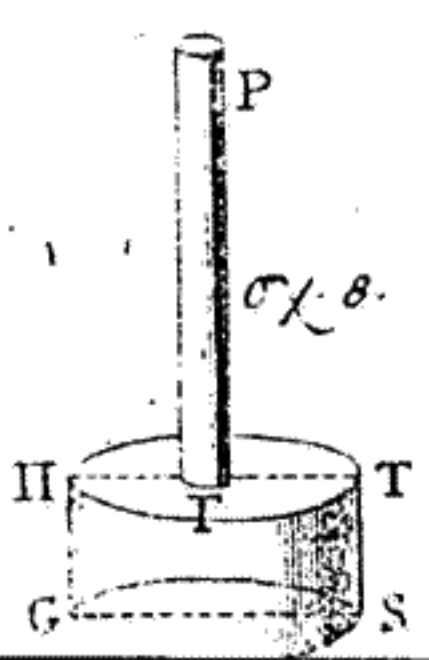
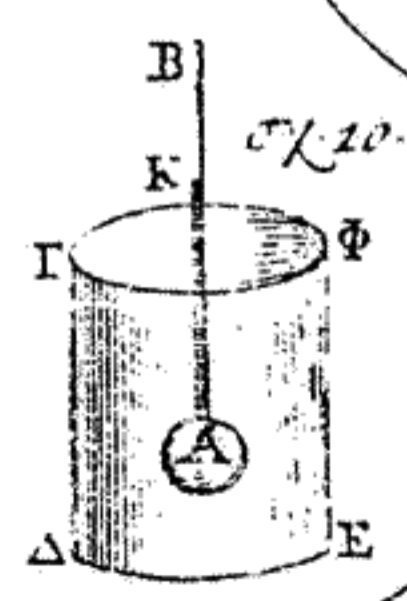
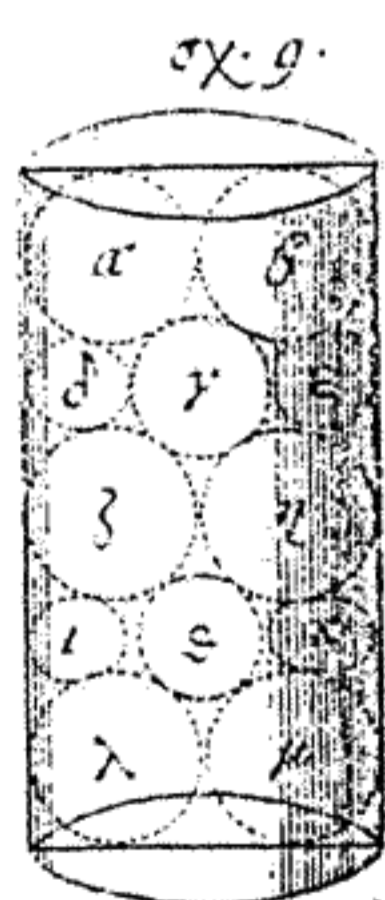
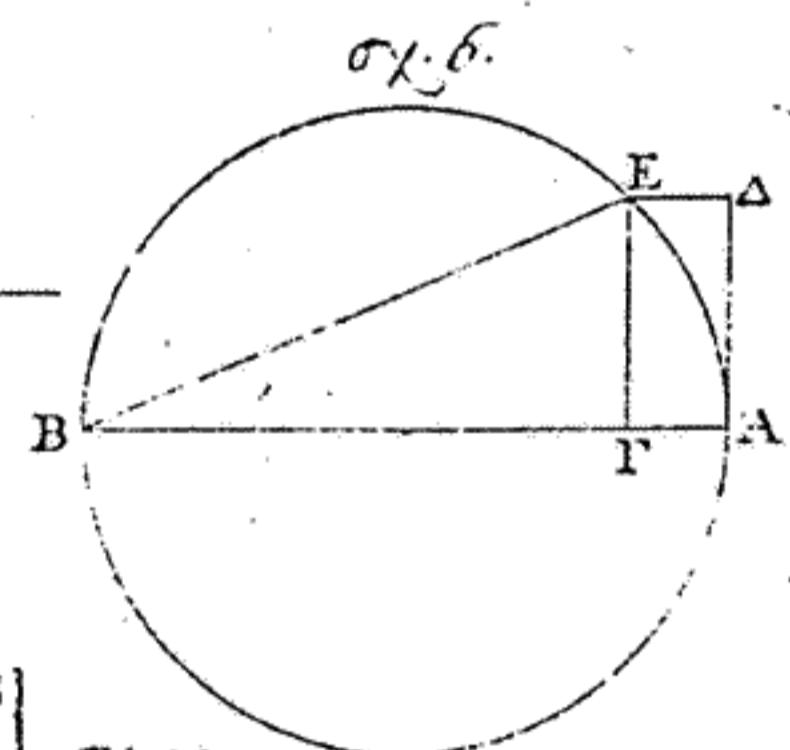
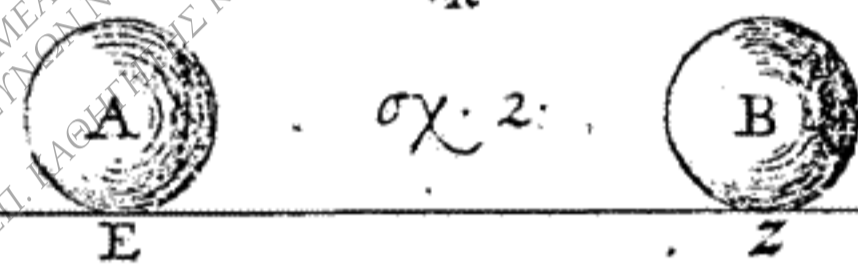
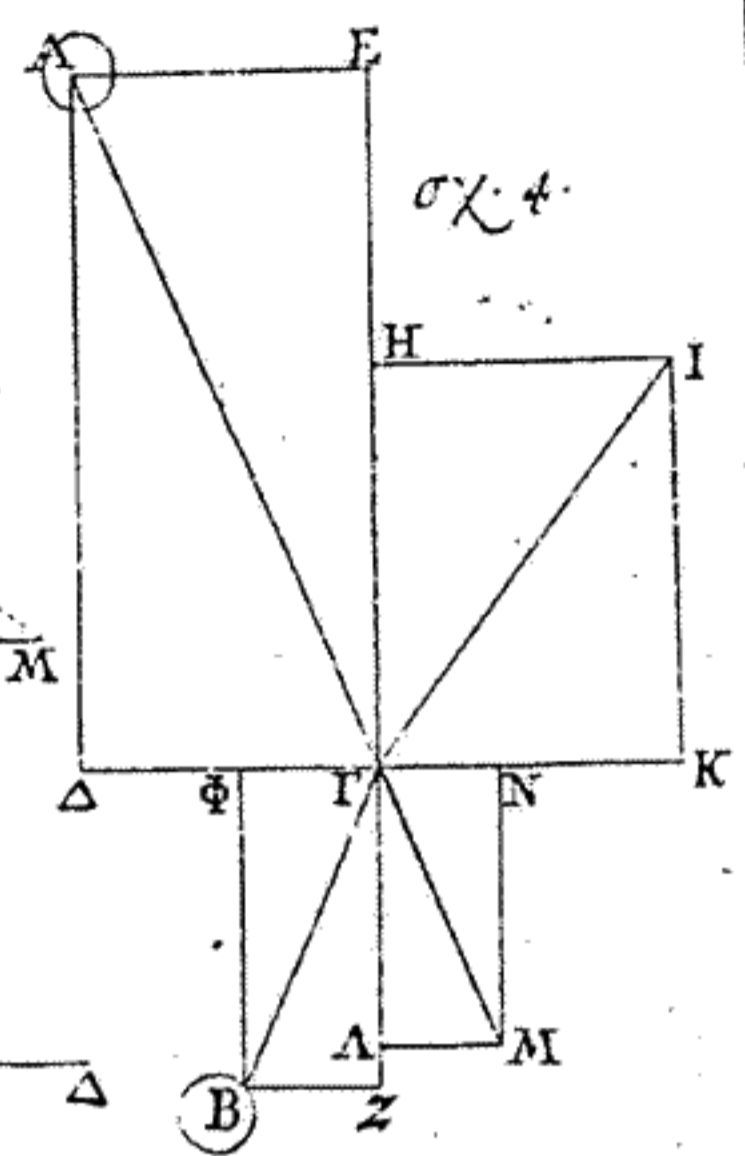
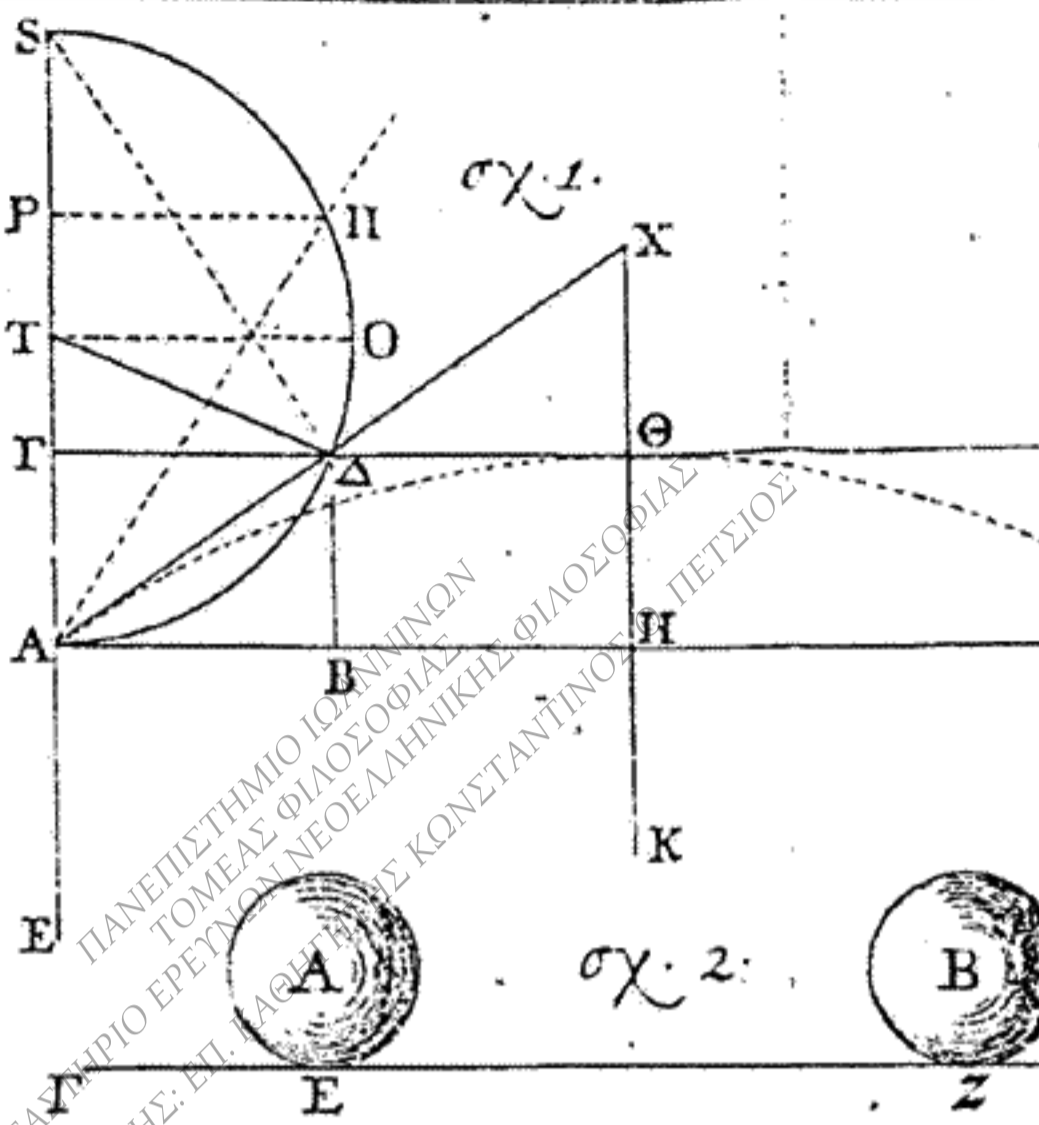

Ε.Υ.Δ της Κ.τ.ΕΙ
ΙΩΑΝΝΙΝΑ 2006

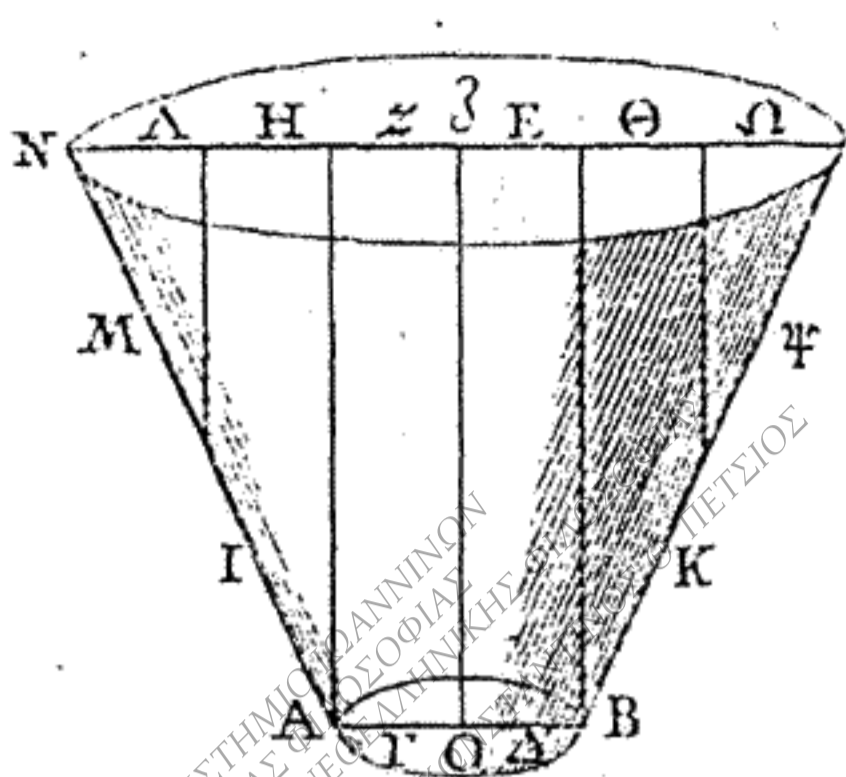

σχ. 1.

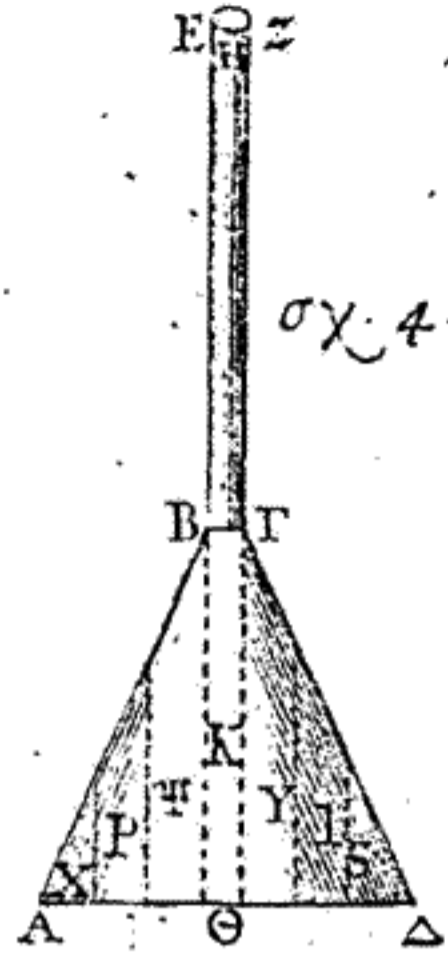

σχ. 4.

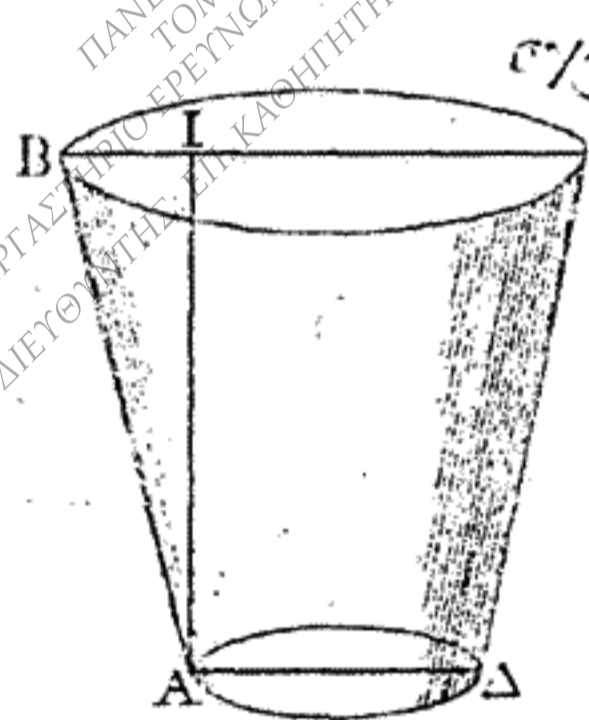

σχ. 2.

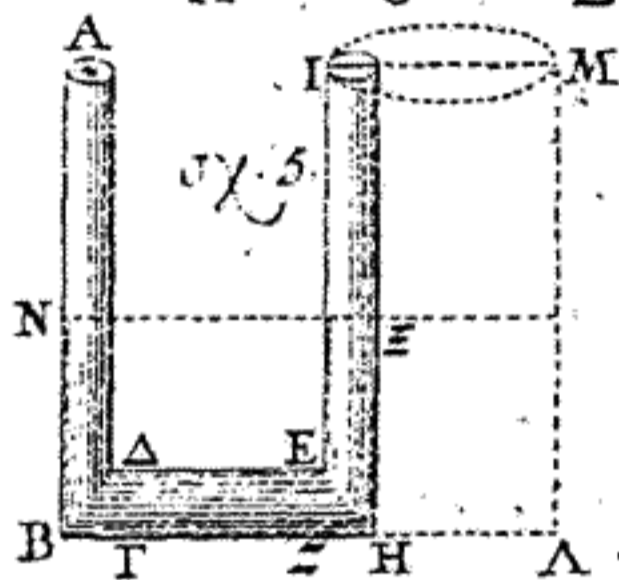

σχ. 5.

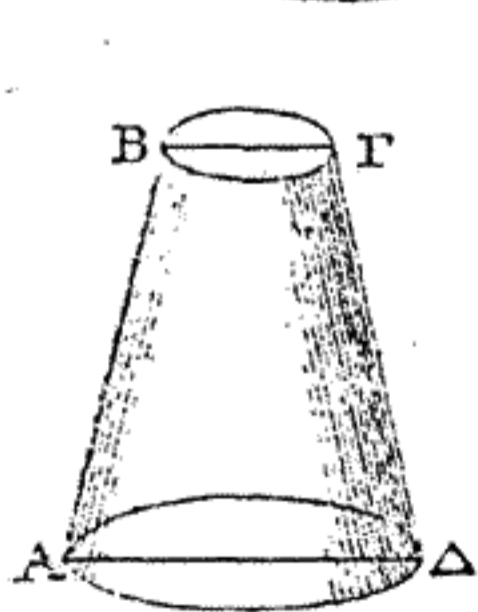

σχ. 3.

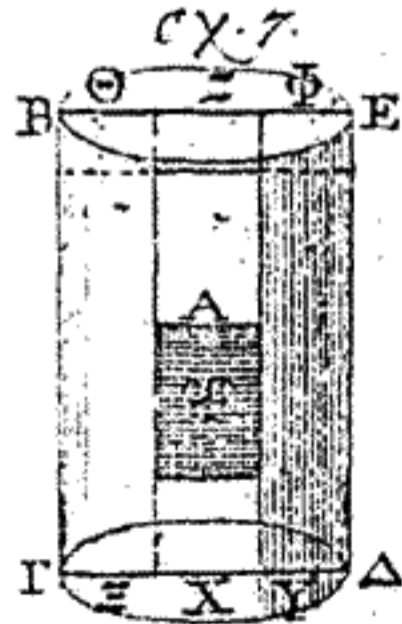
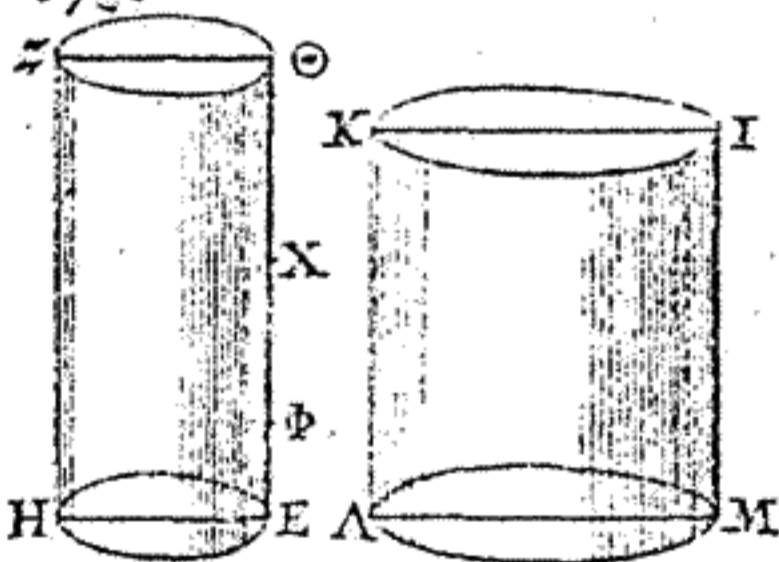

σχ. 7.

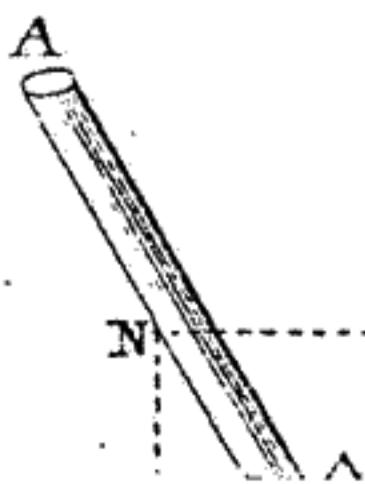

σχ. 6.

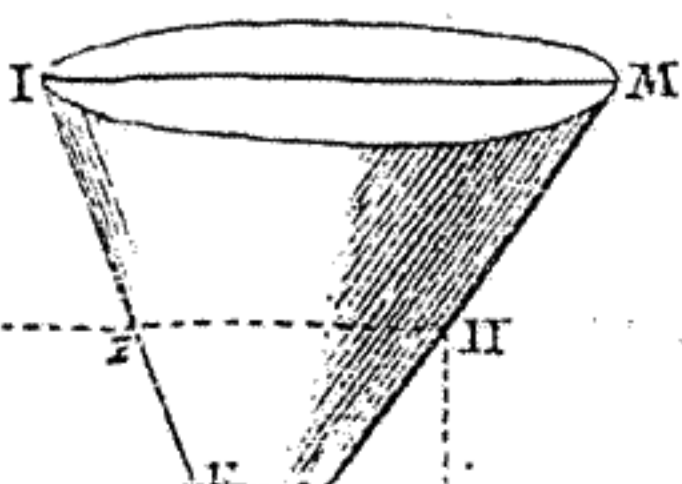

σχ. 8.

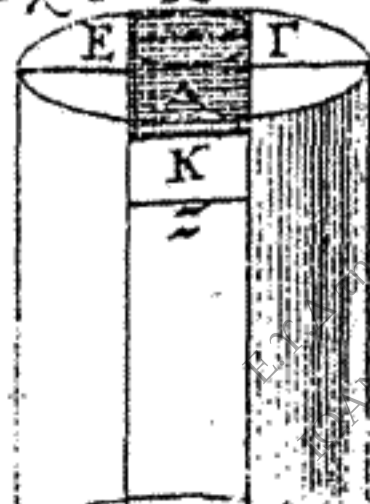

ΠΑΝΕΠΙΣΤΗΜΙΟ ΘΡΑΚΗΣ
ΤΟΜΕΑΣ ΦΙΛΟΣΟΦΙΑΣ
ΕΡΓΑΣΤΗΡΙΟ ΕΡΕΥΝΩΝ ΝΕΟΛΟΓΩΝ
ΔΙΕΥΘΥΝΤΗΣ: ΔΡ. ΚΑΘΗΓΗΤΗΣ ΚΩΣΤΑΣ ΠΑΠΑΝΙΝΑΣ

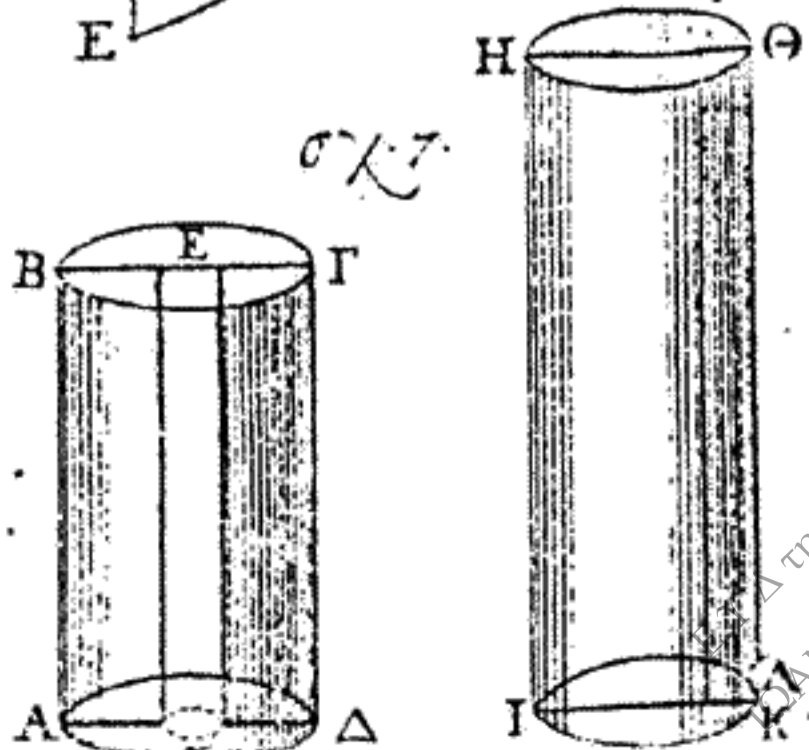
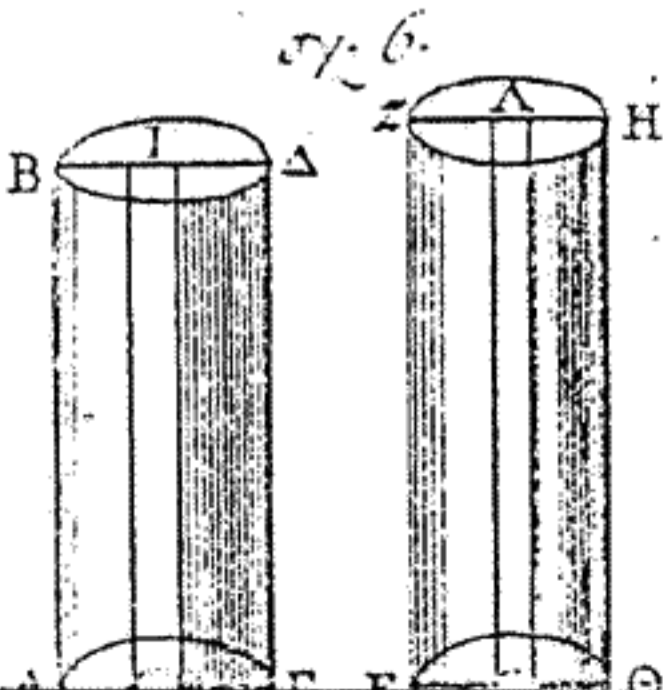
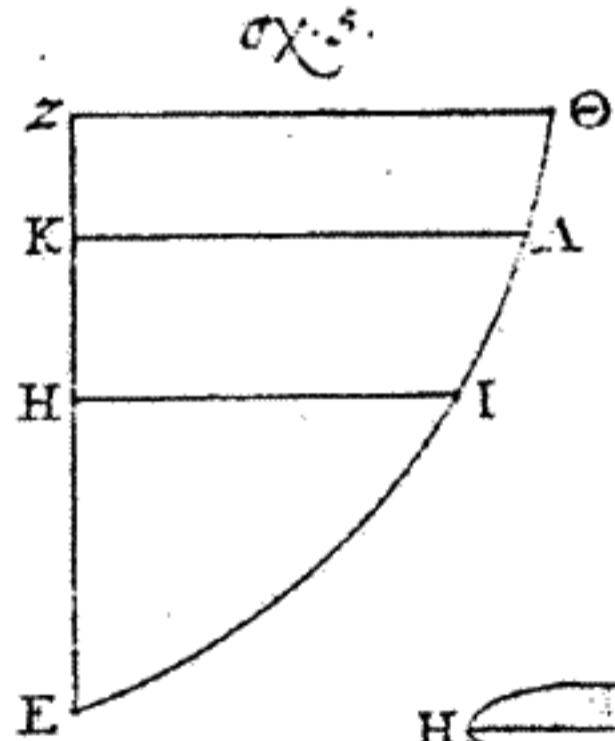
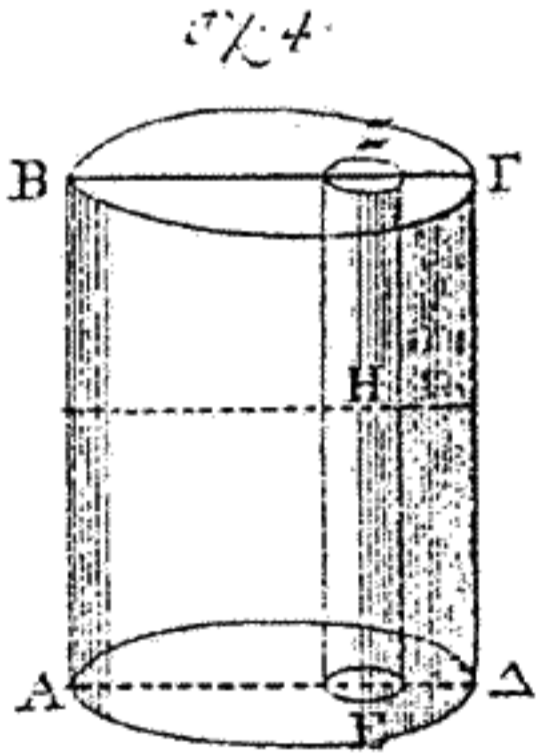
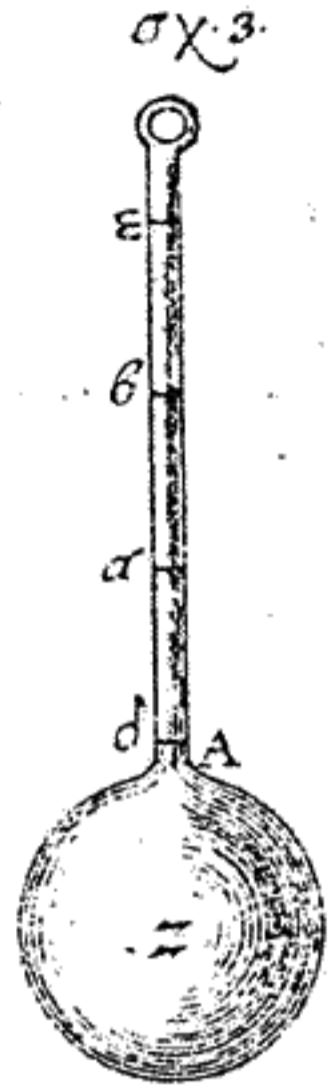
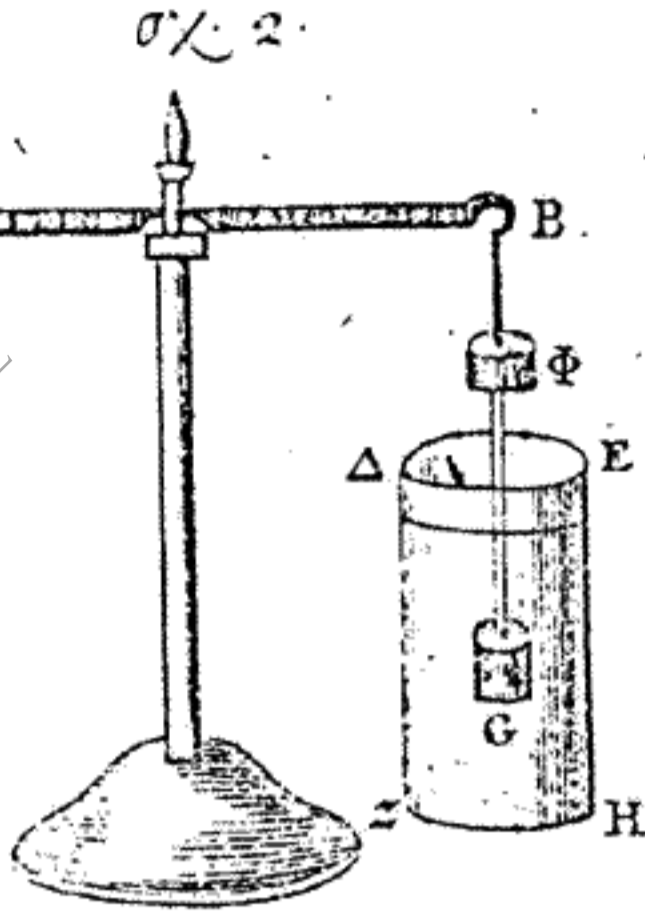
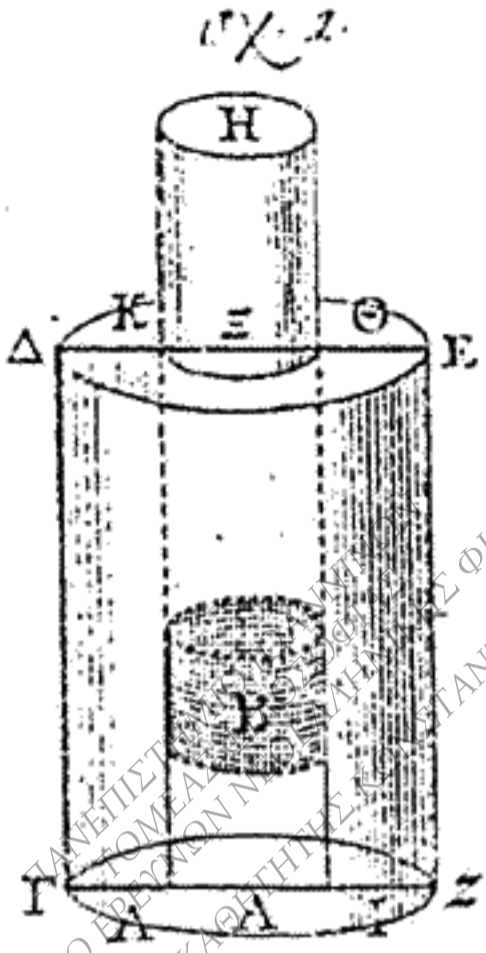

ΕΡΓΑΣΤΗΡΙΟ ΦΙΛΟΣΟΦΙΑΣ
 ΔΙΕΥΘΥΝΤΗΣ: ΕΠ. ΚΑΘΗΜΕΡΗΣ ΚΩΝΣΤΑΝΤΙΝΟΣ Θ. ΠΕΤΣΙΟΣ

Δ. της Κ.τ.Π.
 ΔΙΑΝΝΙΝΑ 2006

σχ. 1.

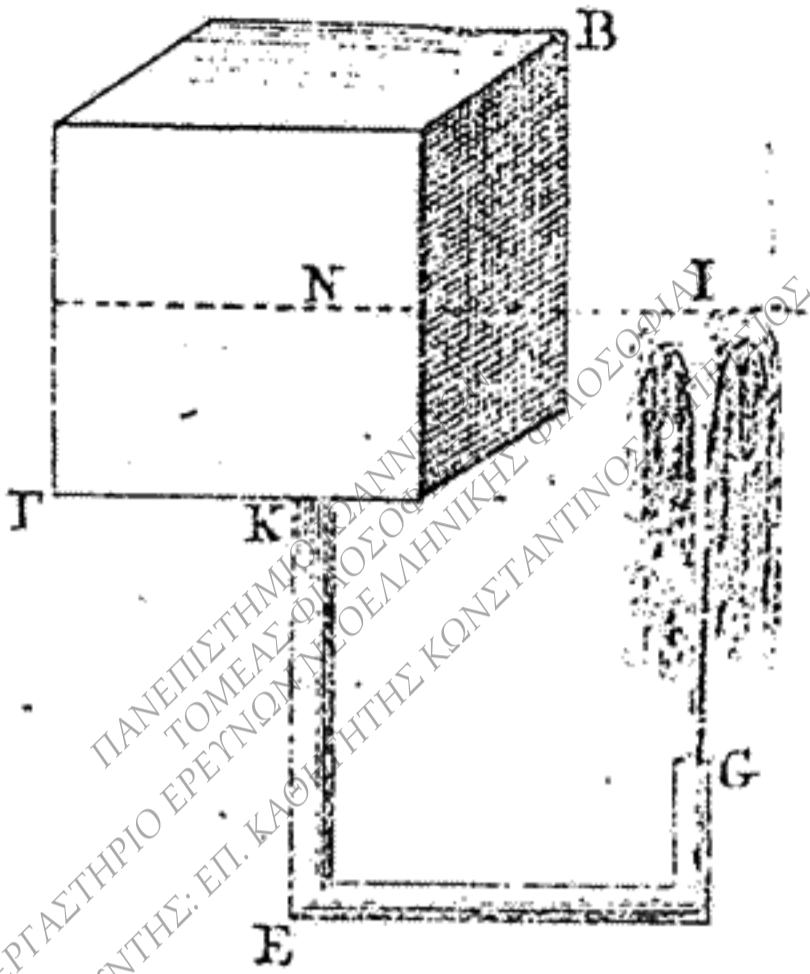

σχ. 2.

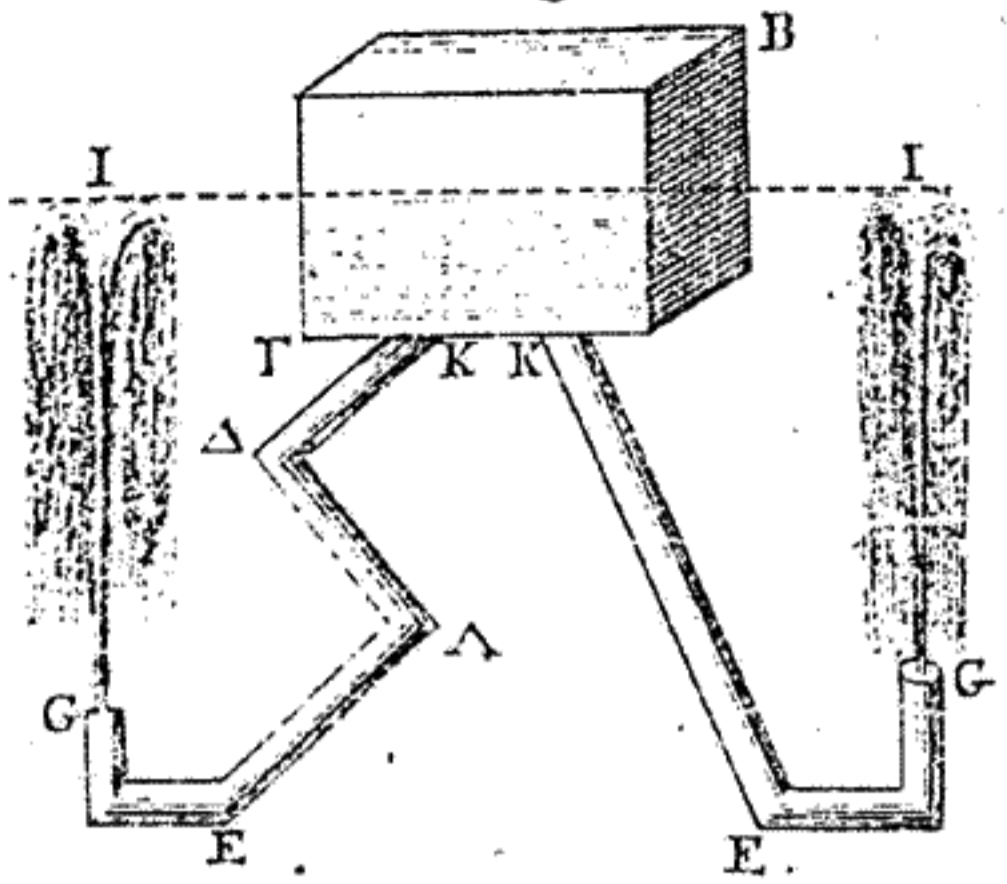

σχ. 3.

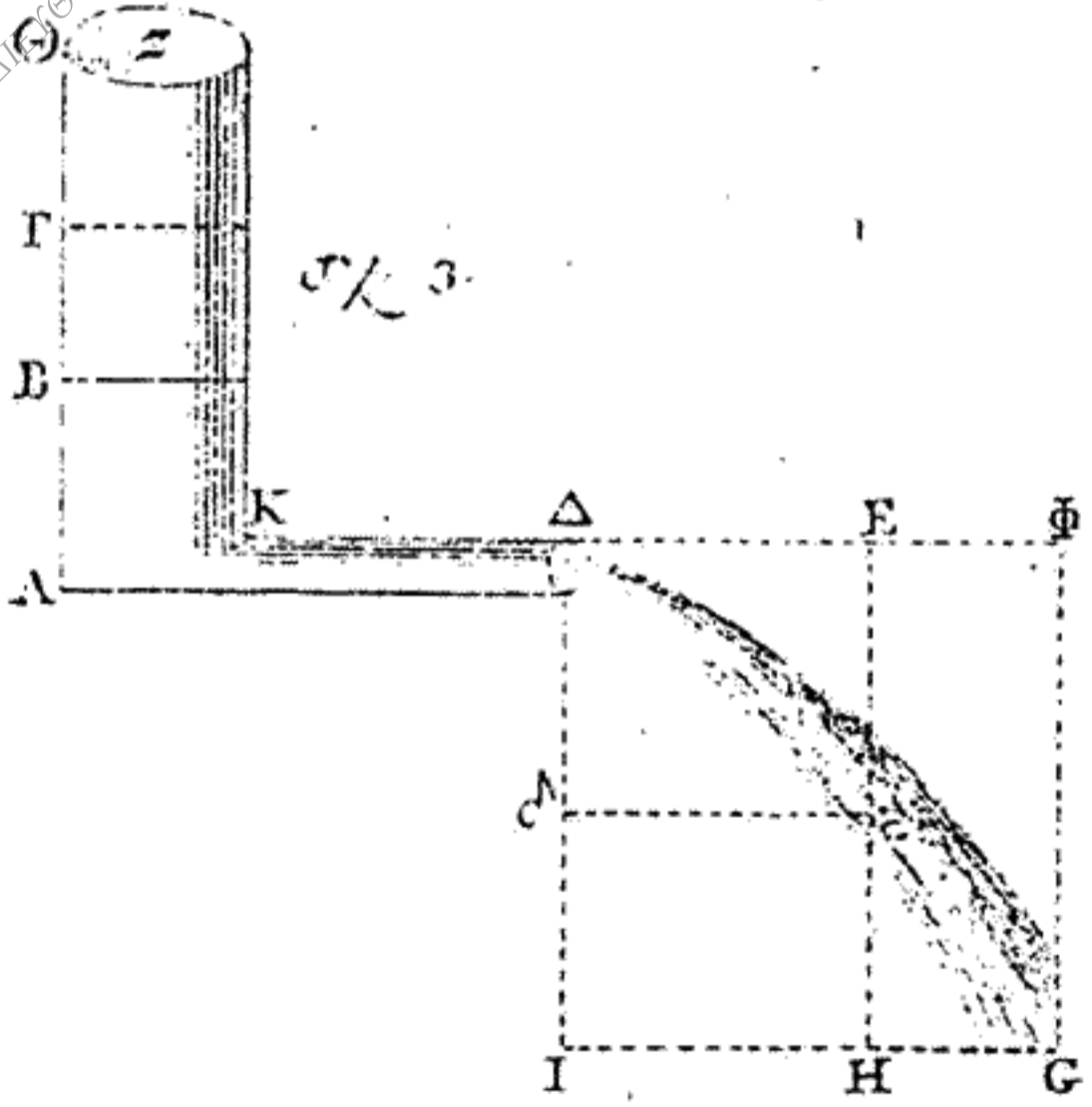

σχ. 5.

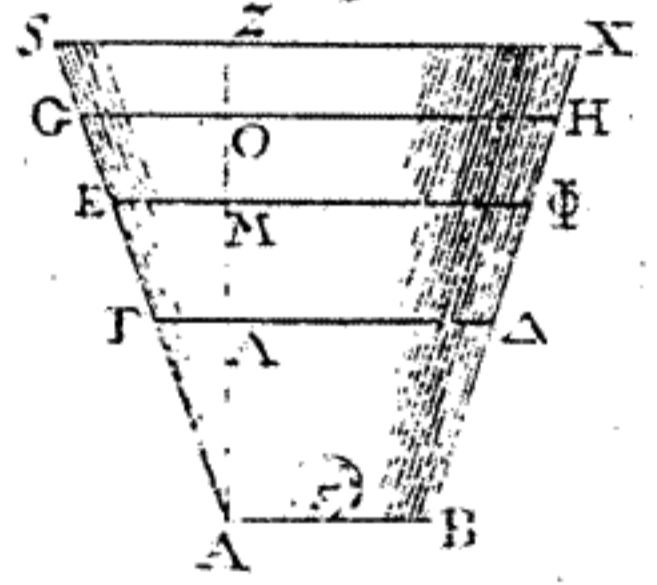

σχ. 4.

